

Report to the University of Hawaii at Manoa on the Hydrogen/Oxygen Explosion of March 16, 2016

Report 1: Technical Analysis of Accident

Prepared by the UC Center for Laboratory Safety, June 29, 2016

Investigative Team:

Dr. Craig Merlic, Executive Director, University of California Center for Laboratory Safety, Associate Professor, Department of Chemistry and Biochemistry, UCLA

Mr. Eugene Ngai, President, Chemically Speaking LLC, Whitehouse Station, NJ

Dr. Imke Schroeder, Research Project Manager, University of California Center for Laboratory Safety, Adjunct Associate Professor, Microbiology, Immunology and Molecular Genetics, UCLA

Mr. Kenneth Smith, CIH CHP, Board Member, University of California Center for Laboratory Safety, Executive Director for Environmental Health & Safety, University of California

Table of Contents

Executive Summary: Report 1	4
Introduction and Goals of Investigation	6
Incident Timeline	6
Events Leading Up to the Accident	7
Research Background.....	7
Research Funding	8
Safety Considerations in the UH Laboratory	9
No answers to the researcher’s questions were found and further safety concerns were no longer present in subsequent meeting notes or in the postdoctoral researcher’s laboratory notebooks.....	10
Bacterial Cell Culture in Bioreactors.....	11
Use of a Gas Storage Tank to Contain H ₂ , O ₂ , and CO ₂	13
Procedure to Fill the Gas Storage Tank with H ₂ , O ₂ , and CO ₂	16
Procedure to Remove a Gas Sample for Analysis	16
Experiments Involving the Gas Storage Tank	17
Near Miss Incident in the Same Laboratory	18
Analysis of Events Leading Up to the Accident	19
Safety Issues Noted with Equipment Used for Explosive Gas Mixture	19
General Safety Problems in Academic Research Laboratories	20
Managing Experimental Changes	22
Hydrogen Gas Safety	22
Response to Near Miss Event.....	23
Accident Description and Analysis	23
Potential Causes of the Storage Tank Rupture	32
Potential Causes of the Gas Mixture Ignition	34
Causality of the Detonation	37
Honolulu Fire Department Report	37
Forensic Examination and Testing	40
Grounding and Bonding	42
Likely Cause of Detonation	43
Conclusions on the Accident Event and Cause	47
Other Accidents Involving Hydrogen	48
APPENDICES	50
Appendix A: Initialisms and Acronyms	50
Appendix B: Terminology	52
Explosion Proof	52

Intrinsic Safety	54
Rotameters	55
Appendix C: Marking and Labeling of Cylinders and Gas Piping	57
Appendix D: Compressed Gas Safety Standards and Regulations	58
Federal OSHA Regulations:	58
International Fire Code	59
Appendix E: Compressed Gas Safety Guidelines	61
Compressed Gases.....	61
General Guidelines for Compressed Gas Safety	64
Guidelines for Cylinder/Pressure Vessel Filling Safety	67
Appendix F: Forensic Testing Report	70
Appendix G: Biographies	71
Dr. Craig Merlic	71
Mr. Eugene Ngai	71
Dr. Imke Schroeder	72
Mr. Kenneth Smith.....	72
WHA International	73

Executive Summary: Report 1

This is an investigative report of the March 16, 2016 hydrogen/oxygen explosion at the University of Hawaii at Manoa campus (UH), in which a postdoctoral researcher lost her arm and sustained burns to her face and temporary loss of hearing. The postdoctoral researcher was working in a laboratory at the Hawaii Natural Energy Institute in the Pacific Ocean Science and Technology (POST) building.

This investigation was performed by the University of California Center for Laboratory Safety at the request of UH. The University of California Center for Laboratory Safety, in its capacity as an independent third party review team, was contracted to investigate the circumstances that led to this laboratory accident. The investigation included multiple visits to the site of the explosion as well as other UH research laboratories, examination of physical evidence and documents, testing of equipment remaining after the incident, testing of identical equipment, and interviews with UH staff and administrators, Environmental, Health and Safety Office (EHSO) staff, research faculty, graduate students and postdoctoral researchers. The report is separated into two sections. The first report presents conclusions regarding the technical details of the explosion as well as presenting an analysis of its immediate cause. This report also provides an in-depth review of the documentation, physical evidence recovered from the incident scene, a detailed analysis of possible causes and a summary of the forensic testing performed on the equipment involved in the accident. The second report contains recommendations for improvement of the UH research safety operations.

The immediate cause of the accident was traced to the digital pressure gauge which acted as a path to ground for a static charge that ignited the hydrogen/oxygen gas mixture contained within a 13 gallon (50 liter) pressure tank. Extensive analytical testing of an identical gas tank/pressure gauge system did not reproduce a stray electrical current within the digital pressure gauge suggesting that the initiation event was due to a static discharge generated in the tank or the researcher. The explosive gas mixture was most likely ignited when the statically charged researcher touched the metal housing of the gauge and a charge transfer occurred causing a corona or brush discharge within the gauge stem.

While the likely point of initiation of the explosion was determined to be due to static discharge through the digital pressure gauge, it should be emphasized that there are numerous means by which a hydrogen/oxygen gas explosion can be initiated. It is imperative that, hydrogen/oxygen gas mixtures in the explosive range should not be stored, and experiments using hydrogen/oxygen gas mixtures, such as the culture of hydrogen-oxidizing bacteria, should undergo rigorous hazard analysis and mitigation efforts to eliminate possible sources of ignition.

This accident at the UH laboratory showcases once again the challenges that academic research laboratories face in addressing physical hazards of experimental processes and recognizing potential hazardous consequences when experimental procedures are changed. In scientific research the experimental outcome often becomes the driving force and overrides risk considerations. In this respect, the UH lab explosion is similar to the explosion at Texas Tech University and the fire at UCLA¹. Based on the report of the explosion at Texas Tech University by the Chemical Safety Board (CSB), OSHA has

¹ Mulcahy, M. B. *et al.* College and university sector response to the U.S. Chemical Safety Board Texas Tech incident report and UCLA laboratory fatality. *Journal of Chemical Health and Safety* **20**, 6-13, doi:<http://dx.doi.org/10.1016/j.jchas.2012.12.012> (2013).

amended its regulatory standards² by establishing non-mandatory recommendations regarding physical hazards in the laboratory including combustible liquids, compressed gases, reactives, explosives and flammable chemicals, as well as high pressure/energy procedures, sharp objects and moving equipment. The key lessons identified in the CSB report are directly applicable to UH and are included as several of the safety recommendations to UH.

This report was written to serve as a direct call to action for researchers, administrators and EHSO staff not only at the UH, but at all institutions of higher education that conduct research. The recommendations and lessons learned contained herein should be understood and addressed at all universities in order to help prevent laboratory accidents.

² 29 CFR 1910.1450 Appendix A, https://www.osha.gov/pls/oshaweb/owadisp.show_document?p_table=STANDARDS&p_id=10107, accessed 6/2/2016.

Introduction and Goals of Investigation

The goal of this investigation was to establish the cause and underlying conditions leading to the explosion that occurred on March 16, 2016 in the Pacific Ocean Science and Technology (POST) building on the University of Hawaii at Manoa (UH) campus. This report provides an in-depth analysis of the events that led to the accident as well as the accident itself to serve as Lessons Learned for academic institutions and other stakeholders that use explosive gas mixtures to advance current technology. Since gas use was so integral to the accident, there is a focus in this report and the appendices on gas safety.

Incident Timeline

The Hawaii Natural Energy Institute (HNEI) conducts research on renewable energy sources and energy integration into the grid system. The lab involved in the accident is focused on using hydrogen, oxygen and carbon dioxide for the green production of bioplastics and biofuels. For this purpose the lab works with knallgas bacteria, which are capable of capturing the energy from the reaction between hydrogen and oxygen to fix carbon dioxide into cellular components³.

Bacteria were cultured in an open gas system with continuous gas flow. Flow rates of hydrogen, oxygen and carbon dioxide were controlled by mass flow meters⁴, mixed transiently in a gas proportioner and sparged through the bacterial culture. Access gas exited out of the bioreactor into the laboratory fume hood. The lab operated the process since 2013 using various types of bioreactors at 1-3 atm. The postdoctoral researcher involved in the accident entered the lab in October 2015 to develop a closed gas system bioreactor for elimination of gas waste. She was trained in the preparation of gas mixtures using a 1 gallon pressure vessel, which the lab used on a regular basis to supply 70% H₂ : 20% O₂ : 10% CO₂ to small scale liquid and petri dish bacterial cell cultures at a pressure of 2 atm. This setup was used for about 8 months without incident.

The experimental protocol and any necessary changes were discussed in weekly meetings between the postdoctoral researcher and her PI. To streamline the research process using the closed gas system bioreactor they decided to scale-up by pre-mixing the three gases in a 13 gallon gas storage tank. A risk analysis for using the tank with hydrogen and oxygen was not documented. The tank arrived in December 2015 and was leak-tested in January 2016. From the beginning of February until March 16, 2016 the gas storage tank was filled eleven times with varying H₂ : O₂ : CO₂ mixtures, all in the explosive range, with pressures between 37 and 117 psig⁵ (1 atm = 14.7 psig). The experiments were reviewed by the PI and the postdoctoral researcher weekly to discuss improvements of the bacterial culture conditions. They assumed the process to be safe since they stayed well below the maximum pressure for which the gas storage tank was rated (140 psig). The lab received a laboratory safety inspection in January 2016, however, the use of the gas storage tank was not questioned because the inspection used a typical checklist focusing on storage of chemicals and chemical waste, gas cylinder storage, laboratory fume hood certification, and documentation of training.

³ Matassa, S., Boon, N. & Verstraete, W. Resource recovery from used water: The manufacturing abilities of hydrogen-oxidizing bacteria. *Water Research* **68**, 467-478, doi:<http://dx.doi.org/10.1016/j.watres.2014.10.028> (2015).

⁴ Appendix B

⁵ psig stands for pounds per square inch gauge. A more detailed definition can be found in Appendix A.

One day before the accident, on March 15, 2016, the postdoctoral researcher reported a “cracking sound” within the 1 gallon pressure vessel to her PI. The reaction occurred when the postdoctoral researcher depressed the On/Off button of the vessel’s digital gauge. The researcher opened the vessel and discovered that the petri dishes inside were singed and cracked. The gauge had a smaller error range and had been added to the experimental set-up in February 2016; it allowed the researcher to more accurately follow gas consumption by the bacterial cultures over time. The gauge was not rated as intrinsically safe⁴. After reporting the incident, the PI strongly advised the researcher not to use the vessel again.

On March 16, 2016 the postdoctoral researcher had filled the 13 gallon gas storage tank for the 11th time and was preparing to reconnect it to the bioreactor. As she pushed the On/Off button of the pressure gauge on the tank, it exploded causing severe injuries to the postdoctoral researcher and devastating the lab plus damaging adjacent labs and hallways. The digital gauge on the gas storage tank was of the same model as the one on the 1 gallon pressure vessel.

Weeks before the accident the postdoctoral researcher had also reported to her PI being electrically shocked when touching the pressure vessel and the gas storage tank. Neither the researcher nor the gas storage tank nor the pressure vessel were grounded. There were no blast barriers of any type in place. Blast barriers are commonly used in chemistry labs working with explosive materials, however, at present they are not commonly used in microbiology labs. The researcher was also not wearing any type of PPE, although due to the force of the blast, this last layer of protection would not have been sufficient to prevent her devastating injuries.

After the accident UH Manoa established a safety committee to review experiments involving highly hazardous substances or processes. The committee is faculty-led and consists of EHSO staff and faculty with expertise in various sectors. Furthermore, HNEI created a Lab Safety Walkthrough guide to assist researchers with laboratory safety compliance such as training and documentation.

Events Leading Up to the Accident

The University of Hawaii at Manoa is a public research university and part of the greater University of Hawaii system. It educates about 19,000 students including undergraduate, graduate students and postdoctoral researchers in 20 colleges and professional schools. The Hawaii Natural Energy Institute (HNEI) is part of the School of Ocean & Earth Science & Technology and conducts research on renewable energy sources and energy integration into the grid system. The Institute consists of 35 faculty and all of the Institute’s research laboratories (about 45) are located in the POST building on the main campus. The explosion occurred in one of the POST basement laboratories, Room 30 (POST 30).

Research Background

The UH laboratory involved in the incident conducts research on the use of hydrogen, oxygen and carbon dioxide for the green production of bioplastics and biofuels as an alternative to commonly used petroleum-based source material. The model organism widely employed for this purpose is a knallgas bacterium, *Cupriavidus necator*⁶, which is capable of capturing the energy from the reaction between

⁶ Formerly known as *Ralstonia eutropha* and as *Alcaligenes eutrophus* before that

hydrogen and oxygen to fix carbon dioxide into cellular components⁷. In concept, this process is similar to light driven CO₂ fixation operated by photosynthetic organisms such as plants. The model bacterium used in the laboratory is well known for its vast production of an intracellular storage material (polyhydroxyalkanoate or PHA), which is the focus of bioplastics and biofuels research in this, and a number of other national and international laboratories. The PI is a well-known expert in the field and has worked with this type of bacterium in his lab since 2008⁸. One of the lab's research efforts centers on optimizing bacterial cell growth to achieve high cell density with maximum PHA content. At the time of the incident, two postdoctoral researchers were involved in culturing the knallgas bacteria. The postdoctoral researcher directly involved in the accident had joined the lab in October 2015 and was personally trained by the PI in preparing gas mixtures for cell growth in a 1 gallon (3.8 liter) pressure vessel⁹. The injured postdoctoral researcher was not available for an interview during the Investigative Team's visit.

Research Funding

The PI's research was funded by:

- **Bio-on.** Bio-on is a private European company formed in 2007 to promote materials production from 100% renewable sources or processing of agricultural waste materials. The company's focus is to generate a green product. Hence, they are interested in the amount of oxygen consumed and carbon dioxide released during its production. Safety recommendations/requirements were not found.
- **Office of Naval Research (ONR).** ONR has specific requirements for research with human subjects, animal research and recombinant DNA molecules relying on academic institutional committees for evaluation and sign off. For use of ammunition or explosives the grantee must provide a copy of a preaward safety survey and security survey upon proposal submission. Only liquid, but not gaseous, hydrogen and oxygen fall under Ammunition and Explosives Safety Standards and a hydrogen/oxygen mixture is not mentioned.

The question has been raised in the safety community whether granting agencies should do more to promote safety within the projects that they sponsor. Indeed, some federal agencies do have specific requirements on safety, but it is not a general practice to require proposals to contain a) identification of hazards in the proposed research, b) strategies how those hazards will be mitigated, and c) information regarding how lab workers will be trained on the project hazards. It should be noted here that neither funding agency requested a risk analysis for this work with explosive materials.

⁷ Matassa, S., Boon, N. & Verstraete, W. Resource recovery from used water: The manufacturing abilities of hydrogen-oxidizing bacteria. *Water Research* **68**, 467-478, doi:<http://dx.doi.org/10.1016/j.watres.2014.10.028> (2015).

⁸ Yu, J., Dow, A. & Pingali, S. The energy efficiency of carbon dioxide fixation by a hydrogen-oxidizing bacterium. *International Journal of Hydrogen Energy* **38**, 8683-8690, doi:<http://dx.doi.org/10.1016/j.ijhydene.2013.04.153> (2013).

⁹ PI interview

An example of a granting agency that requires project safety information within a grant proposal is the Department of Homeland Security (DHS) requirements for a Center of Excellence (COE) grant. To ensure that researchers and research facilities funded through the DHS COE award meet the highest safety standards possible, DHS requires every recipient to develop a Research Safety Plan. The Research Safety Plan must include, at a minimum, the following:

- Identification of possible research hazards associated with the types of research to be conducted.
- Research protocols or practices that conform to generally accepted safety principles applicable to the nature of the research.
- The recipient's processes and procedures to ensure compliance with the applicable protocols and standards.
- The recipient's processes and procedures to ensure the prevention of unauthorized activities conducted in association with the research.
- Faculty oversight of student researchers.
- Research safety education and training to develop a culture of safety.
- Access control, where applicable.
- Independent review by subject matter experts of the safety protocols and practices.

Safety Considerations in the UH Laboratory

Prior to the accident, safety concerns were discussed by the PI and the postdoctoral researcher involved in the accident. In fact, before accepting the postdoctoral researcher into his lab the PI sent out a written interview that contained the following question: "What was your duty and responsibility for the Environmental Health and Safety in the laboratories?"¹⁰

The postdoctoral researcher answered as follows: "Before work is started I ensure all COSHH forms¹¹, BioCOSHH, and risk assessments are filled in or are up to date. During experimental work I ensure I am wearing the correct personal protective equipment, and use a fume hood where appropriate. During and/or after experimental work I ensure all waste chemicals have been safely and appropriately disposed of."

Including safety questions in an interview enables a PI to examine general safety perceptions and attitude of a candidate, which is not commonly done. The Investigative Team is not aware of guidelines for incorporating safety questions into such an interview process, hence the safety concern reflects the PI's genuine interest in laboratory safety.

¹⁰ Written postdoctoral researcher/PI interview

¹¹ COSHH stands for Control of Substances Hazardous to Health and is a regulation of the U.K. Health and Safety Executive (HSE), the British OSHA equivalent. <http://www.hse.gov.uk/coshh/basics/assessment.htm>, accessed 6/1/2016.

Also, the postdoctoral researcher included safety considerations into weekly status notes she emailed to her PI prior to meetings with him. The notes for the 10/17/2015 meeting state:

- *"I have completed Haz waste training*
- *I have general lab safety training tomorrow am*
- *Biological safety next week - therefore I shall shadow in the lab at the start of next week to gain understanding of methodologies etc. I can then start in the lab independently on the 22nd Oct."*

Her interest in safety as it directly related to the experiments she conducted were expressed in meeting notes from 10/21/2015. These also reflect her safety training in the United Kingdom where COSHH forms (hazard assessments) are an established component of planning experiments:

- *"Gas supply - Please could we look into this together quickly. Would I combine H₂ and CO₂ in one cylinder and then add O₂ separately?*
 - *Several papers have discussed the need for the O₂ levels to below 4.0-6.9%-lower explosion limit. Is this something we need to consider? If we work with higher limits on a small scale are they safe to scale up?*
 - *PPE - would I need a flame proof lab coat? If so airgas sell them for \$106.*
 - *Would all gases need to be supplied at the same pressure - due to different Henry's constants, should just O₂ and H₂ be pressured?*
- *Any SOP's that have been written for the lab?*
 - *Should I write my risk assessments / COSHH forms¹² or is there general lab ones that I just need to read over?*
- *I have now completed lab safety, Haz, and Biosafety training. Can I now start in the lab?*
 - *Arrange to shadow tomorrow*
 - *Training on prep, storage and inoculation of microorganisms"*

No answers to the researcher's questions were found and further safety concerns were no longer present in subsequent meeting notes or in the postdoctoral researcher's laboratory notebooks.

The 10/21/2015 meeting entry illustrates that the postdoctoral researcher originated from a research environment with a more rigorous culture of safety:

- Safety training is recognized as important
- The importance of SOPs is well understood
- Formal risk assessment is needed prior to experimentation
- The hazards of an explosive gas mixture is well recognized and literature pointing to safer solutions is considered
- PPE is considered important

¹² COSHH stands for Control of Substances Hazardous to Health and is a regulation of the U.K. Health and Safety Executive (HSE), the British OSHA equivalent. <http://www.hse.gov.uk/coshh/basics/assessment.htm>, accessed 6/1/2016.

Bacterial Cell Culture in Bioreactors

To maximize bacterial synthesis of PHA for bioplastics and biofuel production *C. necator* is cultured to very high cell density¹³. When *C. necator* is cultured with gases the process is hampered by the low solubility of H₂, O₂ and CO₂ in liquid nutrient solution, in which the bacteria thrive. For energetic reasons, the cellular demand for H₂ and O₂ is much higher than that for CO₂. As the bacteria multiply H₂ and O₂ are rapidly consumed and cells typically stop growing when O₂, as the limiting gas, is depleted. Therefore, research on PHA production with H₂, O₂ and CO₂ focuses on supplying sufficient gas and varying gas ratios to establish optimal conditions for cell growth.

Gases are normally supplied from individual gas cylinders equipped with dedicated pressure regulators and connected to gas mass flow meters¹⁴ either by copper or other gas appropriate tubing. Regulators reduce the pressure of the gas exiting the cylinders and gas mass flow meters regulate the gas flow rate, which is important when combining gases at certain ratios. The gases are mixed transiently in a gas proportioner and enter the bioreactor (Figure 1). In most knallgas bacteria bioreactors, the gas mixture percolates through the bacterial culture under vigorous mixing and exits through an exhaust line. Much research has been done on various mixing techniques to improve gas solubility in liquids and reduce the amount of gas wasted through the exhaust line. For *C. necator* the conventional gas supply consists of a gas ratio of 70% H₂ : 20% O₂ : 10% CO₂¹⁵, although the gas ratios could vary¹⁶. This type of open gas system for bacterial cell culture was also operated in the UH lab at the time of the accident.

¹³ Ienczak, J. L., Schmidell, W. & Aragão, G. M. F. High-cell-density culture strategies for polyhydroxyalkanoate production: a review. *Journal of Industrial Microbiology & Biotechnology* **40**, 275-286, doi:10.1007/s10295-013-1236-z (2013).

¹⁴ Appendix B

¹⁵ Yu, J., Dow, A. & Pingali, S. The energy efficiency of carbon dioxide fixation by a hydrogen-oxidizing bacterium. *International Journal of Hydrogen Energy* **38**, 8683-8690, doi:<http://dx.doi.org/10.1016/j.ijhydene.2013.04.153> (2013).

¹⁶ Przybylski, D. *et al.* Exploiting mixtures of H₂, CO₂, and O₂ for improved production of methacrylate precursor 2-hydroxyisobutyric acid by engineered *Cupriavidus necator* strains. *Applied microbiology and biotechnology* **99**, 2131-2145, doi:10.1007/s00253-014-6266-6 (2015).

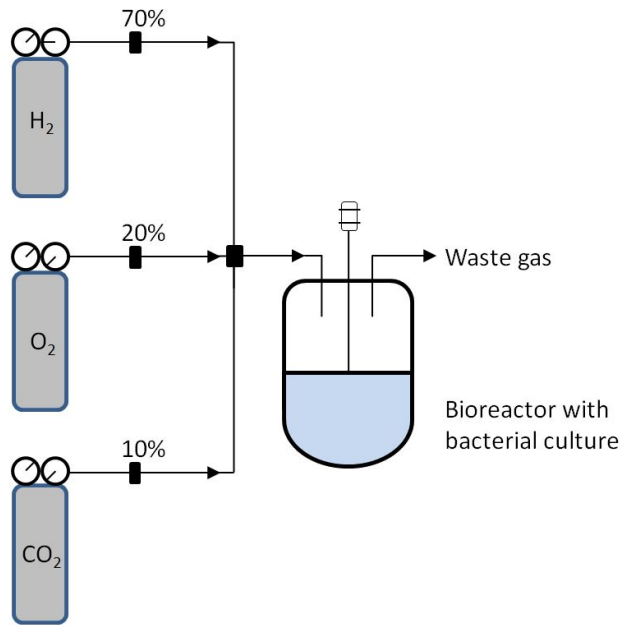

Figure 1: Generic process diagram of gas connections to an open gas system bioreactor in the UH lab showing typical gas percentages.

To reduce the gas waste and optimize the process for industrial applications and commercialization the PI also used a so-called trickle bed reactor in which the nutrient medium is circulated through the bioreactor's solid bed (Pentair filters). A stainless steel, 3.8 L pressurized bioreactor (Parr 5500, rated to 300 psig) was operated for this purpose since 2013 using the 70% H₂ : 20% O₂ : 10% CO₂ gas mixture at 1-3 atm (15-45 psig) pressure (Figure 2). Initially, gases were supplied from three gas cylinders as described above and continuously sparged through the bioreactor. The postdoctoral researcher involved in the accident was tasked with developing a closed gas system to eliminate waste gas and optimize the process for industrial applications and commercialization. Gas mixture was added to the bioreactor and gas supply was closed off once the desired pressure was reached. As the bacteria grew and consumed gases, gas mixture was re-supplied through an automated feedback mechanism.

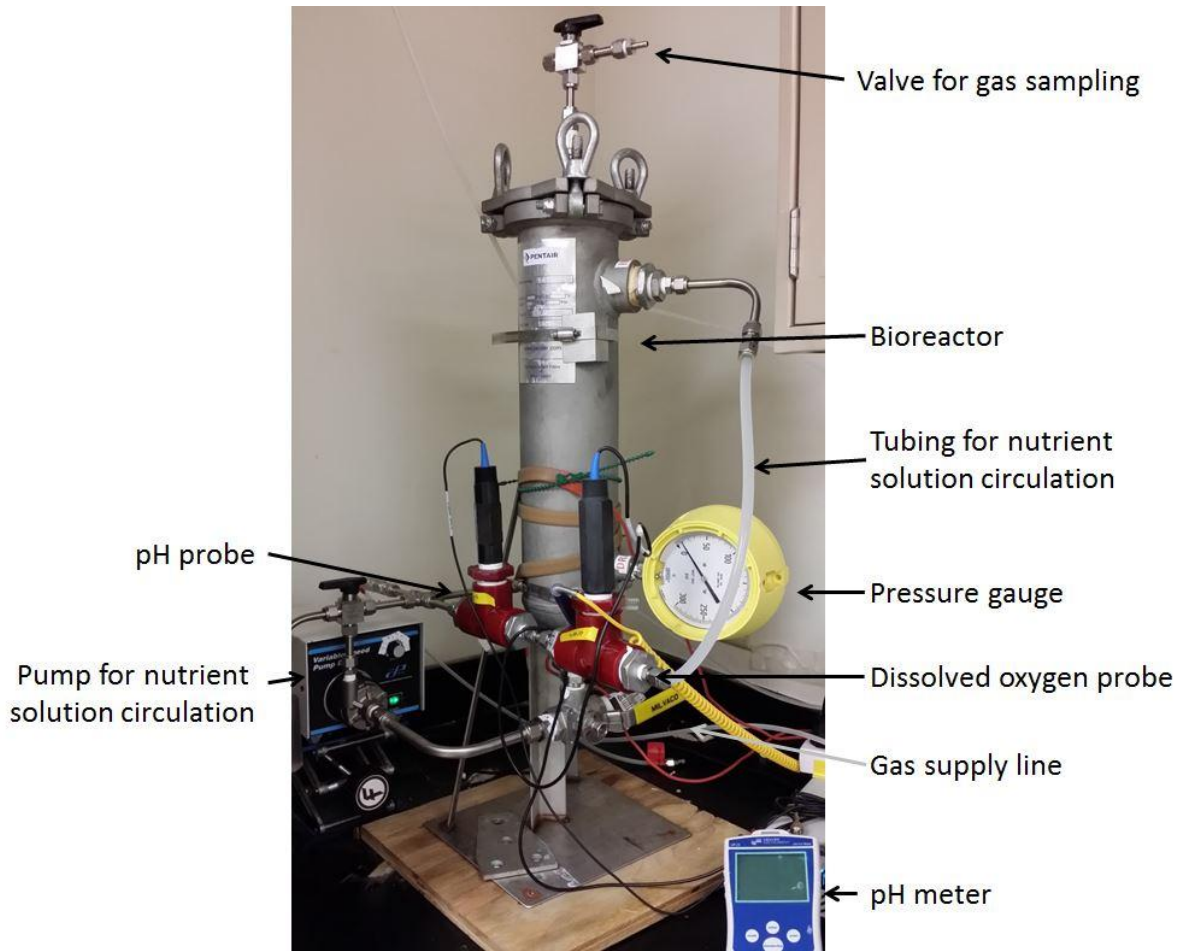

Figure 2: Bioreactor used for pressurized closed system bacterial cell culture. The gas supply line connects in the rear of the bioreactor (not visible) and transports gases from the storage tank. A gas mass flow meter installed between the tank and the bioreactor controls the gas flow rate (not shown).

Use of a Gas Storage Tank to Contain H₂, O₂, and CO₂

Before the researcher joined the lab, the PI had sent her a research proposal outlining an experimental setup of the bioreactor indicating two separate lines for O₂ and H₂/CO₂ gas mixture. Sometime after her arrival, the research team decided to economize the gas mixture supply by combining all three gases (H₂, O₂, and CO₂) into one large gas storage tank. The size of the gas tank was based on the 3-day gas consumption of the 600 mL bacterial culture at high cell density. The premixed gas supply would allow uniform gas delivery over the course of the experiment, but created a large volume of a pressurized explosive gas mixture.

The gas tank and its accessories were ordered from Grainger Industrial Supply on November 6, 2015 and arrived sometime in December. The 13 gallon (50 liter) welded carbon steel gas pressure tank¹⁷ was

¹⁷ Speedaire Air Tank, Grainger # 2TWC3

equipped with an Ashcroft digital pressure gauge¹⁸ rated for 300 psig, a ¼" stainless steel ball valve¹⁹ for admitting gas in and out, an air safety pressure relief valve, and a drain plug at the bottom of the tank (not visible in Figure 3). The gas tank was ASME certified²⁰ with a use pressure of 140 psig and a Maximum Allowable Working Pressure (MAWP) of 168 psig. A 165 psig pressure relief valve was installed by the manufacturer as ASME requires the relief valve to be at or less than the MAWP. Teflon tape²¹ at the gauge and ball valve NPT threads were added by the researchers as a metal lubricant.²²

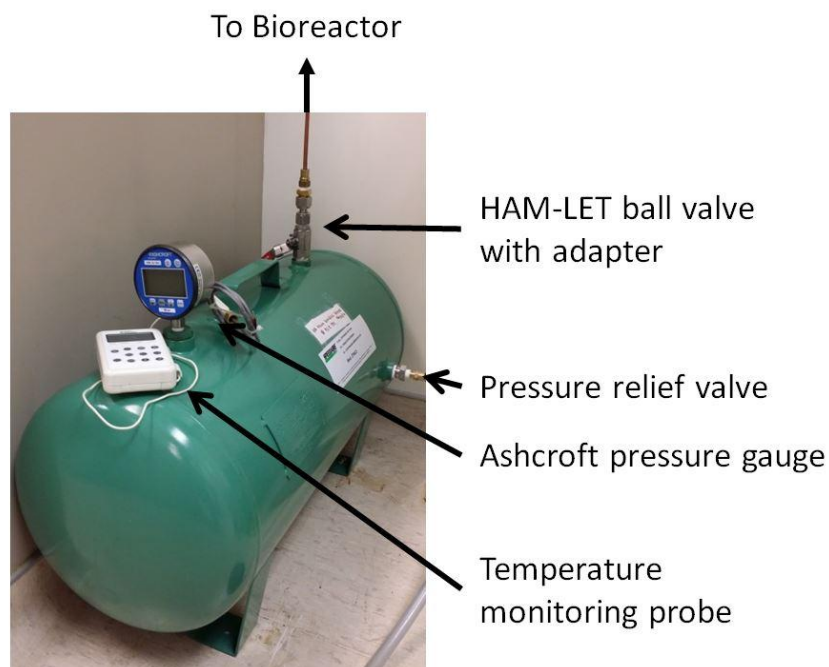

Figure 3: The 13 gallon (50 liter) gas storage tank is shown when connected to the bioreactor. In this image the HAM-LET stainless steel (SS) ball valve is plumbed with copper tubing for gas flow to a gas mass flow controller (not shown). The same ball valve was also used to fill gases into the tank and to remove gas samples for analysis using PE tubing. The red handle attached to the valve (barely visible) moves the valve between the open and closed position, but was blocked from being fully open due to contacting the tank. The pressure relief valve served to release accidental overpressure. The Ashcroft pressure gauge was used to measure the tank's pressure when preparing gas mixture and to follow gas consumption during experimental runs. Wires extending from the back of the gauge could be connected to continuously transmit pressure data, however, they were never used. Tank temperature was initially monitored with a temperature reader; the device was found stored in a drawer by the Investigative Team.

After assembling the tank, the postdoctoral researcher tested the tank for leaks in December 2015 by pressurizing it with the building's air supply. She noticed a leak at the gauge reducing bushing (Figure 4) and later also at the drain valve reducing bushing. Both are straight threaded connections that are sealed

¹⁸ Ashcroft, Grainger # 2AGB6

¹⁹ Grainger #3ZVR5, manufactured by HAM-LET

²⁰ Certification by the American Society of Mechanical Engineers; see Appendix A

²¹ Anti-seize sealant tape, Grainger #4X227

²² N.B. Most people mistakenly believe that Teflon tape is a sealant. It is used to prevent the tapered metal threads from galling as they are being deformed as they are tightened together. This is why only 1 1/2 - 2 turns are used.

with a O ring. She contacted the science instrument technician at the School of Ocean and Earth Science and Technology who replaced badly cracked and compressed O-rings at both bushings that were installed by the tank fabricator. When working on the drain plug the technician noticed rust falling out of the tank. Rust was also observed by the Investigative Team when remnants of the tank were examined (Figure 5). The rust was likely a result of water used for the hydrostatic testing of the tank. During his interview, the technician specifically commented that he assumed the tank would only be used for air and had he been told that it would be used for hydrogen gas, he would not have worked on the tank. He was aware of special requirements for hydrogen gas tanks.

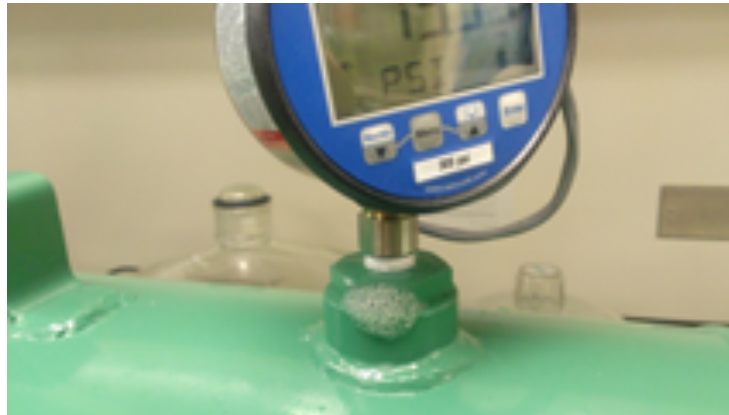

Figure 4: An air leak test done by the postdoctoral researcher using a soap solution indicated air leaks at the gauge and outlet valve reducing bushings (not shown).



Figure 5: Rust inside the damaged gas storage tank as observed by the Investigative Team.

Procedure to Fill the Gas Storage Tank with H₂, O₂, and CO₂

The tank was filled with the three gases sequentially to achieve the predetermined pressure and composition of H₂, O₂ and CO₂. To achieve a 90 psig mixture containing 70% H₂ : 20% O₂ : 10% CO₂, the postdoctoral researcher moved the tank to the area where the H₂ and CO₂ gas cylinders were stored and added H₂ to 63 psig and CO₂ to a 72 psig total gas pressure. She then carried the tank to the opposite side of the lab, where the O₂ cylinders were stored (hydrogen and oxygen cylinders were separated by about 20 feet) and O₂ was added to 90 psig. Each gas addition was made by connecting a polyethylene²³ tubing to the cylinder's gas regulator outlet preset to the required pressure. The gas regulator was opened at a low pressure to flush air out of the tubing for a few seconds, which was then connected to the tank's ball valve. Opening the ball valve allows gases to enter the tank. When reaching the desired tank pressure, as monitored with the digital pressure gauge, the ball valve was closed, the gas tank regulator was closed, and the tubing was disconnected²⁴. If the tank still contained a residual pressure of the gas mixture, the three gases were added at pre-calculated ratios and pressures to restore the intended final gas pressure. According to the postdoctoral researcher's lab notebook the tank was filled 11 times with the gas mixture before it exploded (Table 1).

Procedure to Remove a Gas Sample for Analysis

After filling the tank with the gases, the postdoctoral researcher waited 30-60 minutes before collecting a sample for gas chromatography (GC) analysis. This waiting period allowed for proper mixing of the gases and an accurate analysis. The gas was collected in a gas bag (Figure 6), which was attached via a small piece of polyethylene tubing to the ball valve. The valve was opened briefly to fill the bag and closed again. The postdoctoral researcher had mentioned to the PI that she had some difficulties moving the handle of the gas storage tank²⁵.



Figure 6: Gas sampling bag found in the UH laboratory with polyethylene tubing attached.

²³ Also called Poly Flo tubing

²⁴ PI interview

²⁵ PI interview

Experiments Involving the Gas Storage Tank

A total of five experiments were conducted where the gas tank was used to supply gas mixture to the bioreactor (Table 1). Most experiments ran between 3 and 5 days; experiment #4 ran for 12 days. During the course of the five experiments the gas tank was filled 11 times. The experiments were left unattended after hours. While the experiments were in progress, gas supply and gas pressure of the bioreactor was controlled by a gas mass flow meter connected to the gas tank by copper tubing. The ball valve of the gas storage tank was open during the length of the experiment unless the tank had to be refilled. It was then disconnected and moved to the respective gas cylinder areas to be filled with the gases. The gas pressures used were within equipment limits.

Adjusting the oxygen supply was the most important parameter driving the experiments. Bacterial O₂ consumption was monitored by a dissolved oxygen probe inserted into the bioreactor (Figure 2). To accommodate bacterial O₂ demand O₂ content in the gas tank was increased while H₂ was decreased. Furthermore, O₂ was added separately in intervals.

Table 1: Closed Bioreactor experiments involving Speedaire gas storage tank²⁶.

Experiment #	Date Range	Gas Tank Fill	Gas Tank Initial Pressure (psig)	H ₂ :O ₂ :CO ₂ (v/v%) as Determined by GC ²⁷
1	2/1-3/2016	1 st	37.4	66.3 : 26.7 : 10
2	2/8-12/2016	1 st	69.0	66.9 : 19.8 : 12.2
3	2/22-3/4/2016 ²⁸	1 st	68.1	72.5 : 21.3 : 13.9
		2 nd	66.25	61.9 : 27.7 : 10.4
		3 rd	90.43	61.5 : 32.3 : 6.2
4	3/7-11/2016 ²⁹	1 st	80.0	69 : 21.1 : 9.8
		2 nd	80.9	63.3 : 28.2 : 10.2
		3 rd	99.4	62.3 : 26.7 : 10.4

²⁶ Based on entries in the postdoctoral researcher's lab notebook # 1 and 2

²⁷ Not normalized.

²⁸ Postdoctoral researcher added pure O₂ to bioreactor in addition to gas mixture from gas tank

²⁹ Postdoctoral researcher added pure O₂ to bioreactor in addition to gas mixture from gas tank

5	3/14-3/16/2016	1 st	59.7	68.4 : 20.6 : 11.8
		2 nd	79.7	55.2 : 38.3 : 6.7
		3 rd	117.3	Not determined ³⁰

Near Miss Incident in the Same Laboratory

The day before the 13 gallon (50 liter) gas storage tank exploded, the postdoctoral researcher reported an incident to her PI involving a 1 gallon (3.78 liter) 304 stainless steel Advantec pressure vessel (rated to 140 psig at 38 °C, 316 SS). The vessel is ASME certified and contains four ports for a pressure gauge, a safety valve and two ¼" HAM-LET ball valves (Figure 7). It also has a large access port on top to allow petri dishes to be loaded inside. The vessel was purchased in April of 2015 and its original analog pressure gauge was replaced with an Ashcroft digital (0-100 psig) pressure gauge^{31, 32}, which had a lower error range and allowed to follow bacterial gas consumption with higher accuracy.



Figure 7: Pressure vessel (1 gallon). The pressure vessel as shown here was equipped with an Ashcroft pressure gauge, a pressure relief valve and two ball valves. When found, the pressure gauge showed an unusually high pressure of 60.5 psig.

The pressure vessel was used to incubate petri dishes with solid bacterial cultures under an 70% H₂ : 20% O₂ : 10% CO₂ atmosphere. After pressurization to the intended pressure of 30-45 psig, the

³⁰ The gas composition could not be determined because the tank exploded.

³¹ Ashcroft DG25, 100 psig, ordered 2/17/2016

³² PI Interview, Purchase Orders

vessel was placed into a 30°C incubator oven to provide the optimum temperature for bacterial growth³³. The PI also used the pressure vessel for training purposes; he had trained the postdoctoral researcher on how to prepare a gas mixture in a closed container in October 2015³⁴.

The day before the devastating accident, the postdoctoral researcher reported a “cracking” sound inside the vessel after she had pushed the On/Off button on the Ashcroft pressure gauge³⁵. She had already pressurized the vessel with the specified gas mixture and was about to place it into the incubator oven. Following the noise, the postdoctoral researcher noticed an immediate drop in pressure as hydrogen and oxygen had probably reacted to form water vapor that condensed³⁶. She opened the vessel and noticed a burning smell. The petri dishes were cracked and discolored³⁷. The gas mixture in the incubator may not have been well mixed. As a result a deflagrating reaction occurred that did not transition to a detonation that would have ruptured the incubator.

The postdoctoral researcher was clearly alarmed as she reported the incident to her PI and also to another postdoctoral researcher in the lab³⁸. The PI advised her not to use the vessel again³⁹, however, the Investigative Team found the pressure vessel inside the 30°C incubator oven during their investigation of the UH laboratory. The vessel was pressurized to 60.5 psig and contained bacterial cultures. It was equipped with an Ashcroft pressure gauge, which was sent out for forensic examination. Based on the gauge’s manufacturing date (January 2016), the gauge was the same as the one used during the near miss event.

Analysis of Events Leading Up to the Accident

Safety Issues Noted with Equipment Used for Explosive Gas Mixture

Safety issues noted with bioreactors in operation:

- No pressure relief valve on the pressurized bioreactor
- No safety barricade
- No electrical grounding and bonding

³³ PI interview

³⁴ PI interview

³⁵ Fire Department Report

³⁶ Based on the stoichiometry of the reaction two hydrogen and one oxygen molecule are replaced by one water molecule, resulting in a drop in pressure.

³⁷ PI and postdoctoral lab-colleague interview

³⁸ PI and postdoctoral lab-colleague interview

³⁹ PI interview

Safety issues noted with the gas storage tank:

- Speedaire operating instructions provide safety guidelines stating that the tank is “designed and intended to be used for dry air only.” They also state “Do not use this tank to store or disperse liquids or flammable gases.” and “Failure to comply with these guidelines could result in personal injury and/or property damage due to air tank failure.” This is an inexpensive tank for a homeowner or industrial user to store compressed air.
- The gas storage tank was moved from its experimental use position to two different gas cylinder areas for filling. The tank was not grounded at any of the locations. The postdoctoral researcher reported to the PI of being sparked when touching the tank. Electrical discharges were also noticed by others working in the same building as of February 2016.
- The Ashcroft digital pressure gauge was not designed nor certified to be intrinsically safe⁴⁰. Intrinsically safe devices are systems that have been tested at a 3rd party laboratory and proven to be safe for use in a flammable environment by limiting the energy, electrical and thermal, that could cause an ignition.
- The HAM-LET stainless steel ball valve served as crude control device to add gas from the gas cylinders to the air tank. It also served to withdraw a sample of the explosive gas mixture for Gas Chromatography (GC) analysis. A partially opened stainless steel ball valve can ignite the explosive gas mixture due to flow friction caused by high velocity flow.
- Ball valves can create static charge due to the wiping action of the ball against the Teflon seals when it is rotated open or closed.
- The ball valve on tank was installed too close to the tank to allow the valve to be operated comfortably.
- The gas storage tank was not labeled with the gas mixture it contained.

Safety issues noted with gas sampling:

- Sampling of the tank mixture at pressures of 90 psig and higher using a ball valve and a thin fluorinated ethylene propylene (FEP) 500 mL sampling bag is not a safe practice. The bag pressure could easily have exceeded the burst pressure of <20 psig. A needle valve would be a safer valve to control the flow of a gas sample. In addition, the sample bag was friction fitted over a plastic tube stub rather than attached by a threaded connection and could have easily been dislodged during filling.
- However, any type of valve could cause flow friction and be a point of ignition for an explosive gas mixture and the sampling bag could generate an electro static discharge that could have also ignited the explosive gas mixture. Thus, standard practices with nonreactive gases are not directly transferable to explosive gases.

General Safety Problems in Academic Research Laboratories

Safety problems found in the UH laboratory can also be observed in other academic research laboratories in the United States. These challenges illustrate that integrating research safety can be a

⁴⁰ Intrinsically safe refers to electrical equipment and whether or not the equipment is safe to be operated in hazardous areas. These devices are tested and certified by independent testing companies. See Appendix B: Terminology for more information.

daunting task. It is important to openly discuss safety problems, including in grant proposals and publications, and to reach out to experts in the field if necessary.

The events preceding the UH hydrogen/oxygen explosion bring to light several underlying problems which apply to research laboratories in academic institutions in general. The first is a drive inspired by real and perceived pressures to produce results in order to publish papers and obtain and maintain funding. Researchers' careers are measured by and are dependent upon publication output and amount of funding they bring to the university. Secondly, innovation is at the core of scientific discovery as researchers constantly adapt or change experimental procedures allowing them to overcome limitations or challenges as part of their research process. Third, work with highly hazardous substances or processes is not necessarily perceived by many researcher to be high risk⁴¹.

These practices can lead researchers to place a higher value on experimental outcomes than on research safety. Furthermore, in contrast to highly hazardous biological materials⁴², physical hazards lack regulatory oversight. The tragic accidents at Texas Tech University, UCLA, and now at the UH are stark reminders that the scientific discovery process, especially when highly hazardous chemicals or processes are employed, gravely underestimates the risks involved.

Safety problems in academic research laboratories

- Solving technical challenges in experiments are seen as a higher priority than considering the risks of the process.
- Formal risk assessments are typically not integrated into planning and conducting experimental procedures.
- Formal risk assessments are generally not done when changing experimental protocols involving highly hazardous chemicals or processes. *Experiment planning should include possible scenarios of what might happen based on the change in protocol or chemistry and prepare protection for what might happen. The integration of risk analysis should be an integral part of the discussion with the PI before experimental changes are implemented. If possible, an outside review should be performed involving experts familiar with the type of hazard involved.*
- Choosing or designing equipment for highly hazardous processes is challenging as technical descriptions often do not clearly state safety limitations. A compounding factor is the lack of researcher's knowledge about safety standards, regulations and best practices.
- Design of experiments is often based on peer-reviewed publications within the research area where hazard concerns are not addressed or communicated.
- Research involving highly hazardous compounds or processes is often too specialized for most university EHSO staff to recognize the risks involved, even if they inspect the lab or review the experimental protocol.

⁴¹Schröder, I., Huang, D.Y.Q., Ellis, O., Gibson, J.H. and N.L. Wayne (2016) Laboratory safety attitudes and practices: A comparison of academic, government, and industry researchers. J Chem Health and Safety 23:12-23.

⁴² NIH Guidelines, http://osp.od.nih.gov/sites/default/files/NIH_Guidelines.html, accessed 6/2/2016.

Managing Experimental Changes

A well-established issue in safe development of a process is management of change⁴³. If modifications to experimental designs and protocols are not analyzed at each step, then a series of changes can result in an unsafe final system design, as happened in the case of the UH explosion. The UH lab underwent a series of changes using different types of bioreactors, an open and closed gas system for bacterial cell culture, and different methods of mixing gases that when combined were in the explosive range.

Work with gases or gas mixtures in the flammable or explosive range requires a detailed risk analysis at each step of the experimental procedure. Important is to determine the appropriateness of the equipment.

When considering safe use of equipment for highly hazardous processes manufacturer's instructions can be very helpful. The Parr Instrument Company provides detailed safety instructions for their reactors and pressure vessels stressing safe setup and operations, reactive chemical safety, and operator training⁴⁴. For example, under a section entitled "Consider the Chemistry", the company lists questions for researchers, which are essential components of a risk analysis:

"Is the reaction exothermic? What by-products will be produced and what will be their behavior? What maximum temperature and pressure limits will be observed? Under what circumstances (temperature, pressure and catalyzing agents) might the reaction run out of control? By considering these and any other related safety questions before starting a pressure operation, the user should be able to anticipate any violent chemical behavior and take steps to prevent it."

Furthermore, they call for special caution when using oxygen or other strong oxidizing agents. While Parr's safety recommendations mainly pertain to reactor and vessel safety, their guidelines are general enough to apply to any type of highly hazardous process.

One of Parr's safety recommendations is to "Install and operate the equipment in a suitable barricade, if required." However, universities do not generally have safety requirements for barricades to maintain explosive reactions. Often, small (<1 m²) mobile safety shields are used which would have been insufficient to protect the researcher from the gas tank explosion in this case. Nonetheless, an appropriate blast shield is recommended to protect researchers working with an explosive gas mixture. A blast shield could provide protection from failure of a component, such as a gauge or probe, attached to a reactor rated for high pressures. A hazard analysis should always be completed to assess all aspects of the experimental setup.

Hydrogen Gas Safety

Researchers using explosive gas mixtures or flammable gases in their experiments must know the chemical and physical properties of the gases involved⁴⁵. Hydrogen distinguishes itself from other explosive or flammable gases by its broad explosive range and the small amount of energy it takes to

⁴³ OSHA 3132, <https://www.osha.gov/Publications/osha3132.html>, accessed 6/2/2016

⁴⁴ Parr safety instructions; http://www.parrinst.com/files/230M_Parr_Safety-Lab-Reactors.pdf

⁴⁵ More information can be found in Appendix C, D and E

cause ignition. The properties of hydrogen have to be taken into consideration at all stages of experimental design including the facility, equipment, experimental procedures, planned modifications, and researcher protection and training.

Properties of Hydrogen

- Flammable range 4-75% in air is much broader than methane (natural gas), propane and gasoline vapor.
- Flammable range in oxygen is up to 95%.
- Optimal combustion concentration is 29% in air.
- Under optimal combustion conditions, a minimum energy of 0.02 mJ is required for ignition.
- The minimum ignition energy is lower at higher temperatures, increasing pressure or higher oxygen content.

Potential Ignition Sources for Hydrogen

- Electrical (e.g., static electricity, electric charge from operating equipment)
- Mechanical (e.g., impact, friction, metal fracture)
- Thermal (e.g., open flame, high-velocity jet heating, hot surfaces, vehicle exhaust)

Response to Near Miss Event

One day before the accident, the postdoctoral researcher reported a “cracking sound” within the 1 gallon pressure vessel to her PI. Based on the pressure changes, visual observations, and smell, a combustion had occurred. Yet the researchers apparently dismissed the event as an anomaly even though it involved the same gas mixture and style of pressure gauge as the 13 gallon (50 liter) gas tank. The three researchers in the UH lab knew that hydrogen/oxygen gas mixtures were hazardous, so this near miss event should have triggered a shutdown of operations and initiated a thorough investigation of all procedures. But the significance of this near miss event went unrecognized and nothing happened.

Accident Description and Analysis

A review of physical evidence and test results, has led the UC Center for Laboratory to the following conclusions: After pressurizing the gas storage tank with H₂ and CO₂, the postdoctoral researcher moved the tank in front of the biosafety cabinet near the oxygen cylinders and had just finished adding O₂ using the oxygen cylinder closest to the wall (Figure 8). She closed the oxygen cylinder and disconnected the polyethylene tubing used for adding oxygen to the tank. The tubing was later found in a drawer where she normally stored the tubing. During this time the regulator of the second oxygen tank was in the open position; the tank was continuously feeding oxygen to the bioreactor operated by the second postdoctoral researcher in an ongoing experiment (green line in Figure 8). During this time a hydrogen and carbon dioxide cylinders were also in use to supply gas to the second postdoctoral researcher’s bioreactor.

Based on the visual evidence and the impact damage to the floor, it is likely that the postdoctoral researcher who was injured in the accident, was standing or sitting to the left of the tank in front of the

biosafety cabinet. According to the Honolulu Fire Department report, she reached with her right hand over the tank and depressed the On/Off button on the digital pressure gauge to turn the gauge off. Ignition of the explosive gas mixture occurred which quickly detonated.

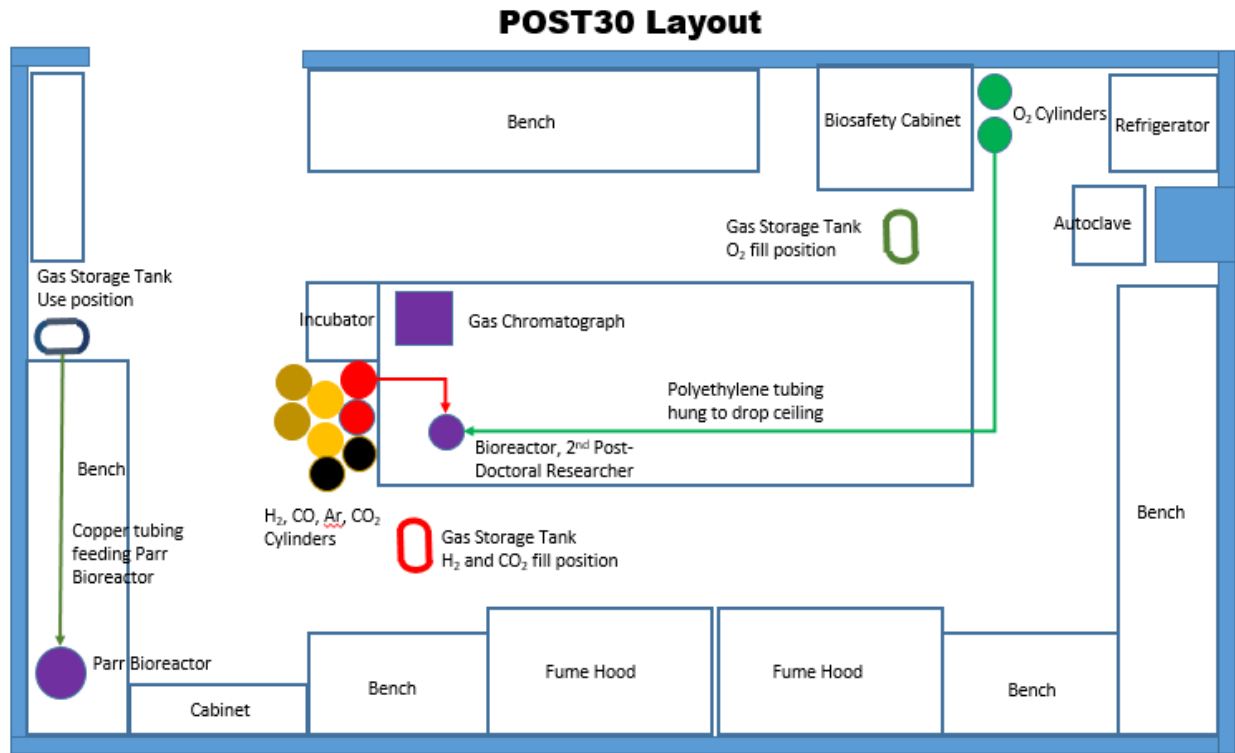

Figure 8: POST 30 laboratory layout. Entry double doors are at the top left. Oxygen cylinders (green) were stored separately from other gas cylinders. The gas storage tank's position is indicated in the position when it was used to feed the gas mixture to the Parr bioreactor (Use position). In front of the biosafety cabinet (O₂ fill position), where it was filled with oxygen and by the other cylinders where it is filled with hydrogen and carbon dioxide (red tank). Green and red (hydrogen) lines indicate gas lines to the second postdoctoral researcher's experiment, which was ongoing during the time of the accident. The carbon dioxide line is not shown.

The tank was violently ripped apart just beyond the pressure gauge which was the origin of the ignition source based on the way the tank ruptured. The reaction propagated horizontally down the tank blowing out the opposite end cap. Figure 9 shows the tank as found by HFD.

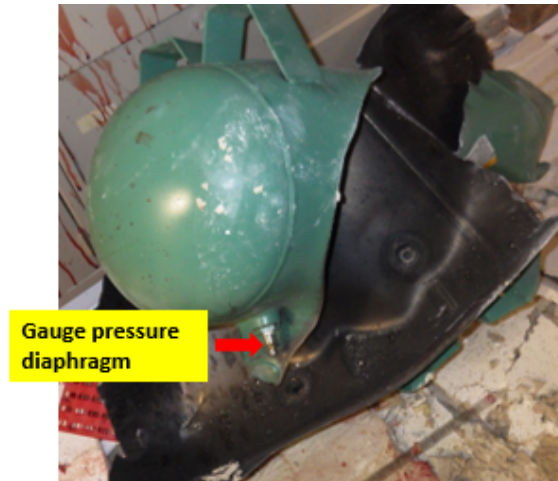

Figure 9: Large section of gas storage tank on floor to the left of the Biosafety Cabinet as found by HFD.

A large section of the tank was violently rolled outward as it tore open. Metal tearing is common to a pressure vessel rupture due to sudden overpressures caused by a deflagrating reaction. The vessel stretches to the elastic limit and ruptures at a point. The escaping gas and the reaction will cause the metal to tear away from the failure point. This tearing is evident in the sharp edges created where the tank came apart. It was propelled upward into the refrigerator and freezer doors (Figures 10 and 11) and then bounced upward, impacting the top panel of the biosafety cabinet. It finally came to a rest on the floor to the left of the biosafety cabinet.



Figure 10: Damage to a -20°C refrigerator and freezer doors in the POST 30 laboratory. The doors show severe impact damage by the gas storage tank piece shown below. The paint residue on the doors match the tank's paint.



Figure 11: The impact distorted edge of the tank that most likely punctured the refrigerator and freezer doors

The end cap of the tank impacted the autoclave to the right of the refrigerator (Figures 12 and 13). It then bounced off the floor in front of the biosafety cabinet, finally coming to a rest on the floor to the left of the cabinet to the right of where the large piece of the tank landed.

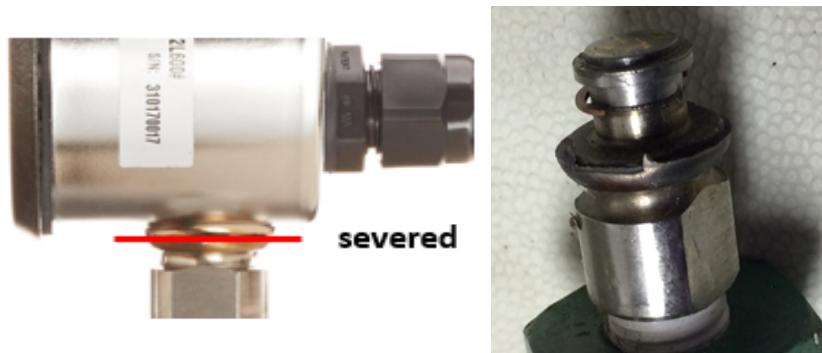

Figure 12: Autoclave impact damage from the smaller tank piece

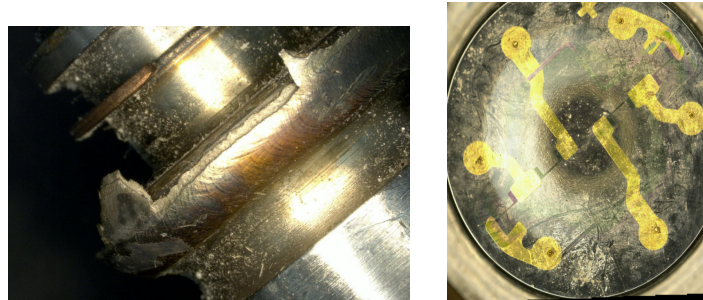

Figure 13: Piece of tank that impacted the autoclave on the floor to left of the biosafety cabinet as found by HFD.

As the large section of the tank was ripping apart, the ball valve assembly bushing was completely torn from the tank around the weld and propelled straight upward into the light fixture directly above it. The impact was so severe that it drove the light panel into the ventilation duct above it damaging it. One section of the large tank piece also rolled inward until it impacted the pressure gauge severing it at the pressure diaphragm stem. (Figures 14 - 17). The pressure gauge stem remained in the reducing bushing that was screwed into the gas storage tank.



Figures 14 and 15: Pressure gauge stem before (new) and after accident.



Figures 16 and 17: Microscopic views of the sensor housing tear and the pressure diaphragm that remained on the tank. Other photos show traces of copper on the diaphragm where the wire leads were torn off during the incident.

When the tank ripped apart, the tank handle and the ASME pressure plate, which were welded to the tank exterior, also came apart from the tank and likely impacted the floor and other objects in the lab. The explosion pressure wave was primarily in the direction of the biosafety cabinet and the refrigerator pushing both into the walls behind them. The right corner of the biosafety cabinet impacted and pushed out the wall forming the 6" apex noted earlier. The overpressure caused ceiling tiles, light panels and other walls to crack (Figure 18 and 19). Many ceiling tiles crumbled forming a large amount of debris that covered the area. Major and minor damage was also caused to adjacent hallways and labs (Figure 20). The windows on both fume hoods, which were across the lab, shattered from the pressure wave.

The force of the explosion caused severe injuries to the researcher including the loss of her lower right arm. The explosive force was so severe that the HFD HazMat 1 entry team⁴⁶ was not able to find any part to reattach⁴⁷. Blood and flesh were found scattered in a wide area throughout the ceiling, floor and benches.

⁴⁶ HazMat 1 is the HFD special operations team that deals with any incidents involving hazardous materials

⁴⁷ Honolulu Fire Dept HazMat 1 interview



Figures 18 and 19: Photographs taken during HFD⁴⁸ response of the explosion scene with torn down ceiling plates and light fixtures. Both pieces of the tank landed to the left of the Biosafety Cabinet. The autoclave with its lid open is visible in the background. Blood from the injured postdoctoral researcher is visible in various places. The inset shows a ceiling light panel from in front of the biosafety cabinet that was impacted by the ball valve assembly and a remnant of the gas storage tank (green) can be seen in the lower left corner.

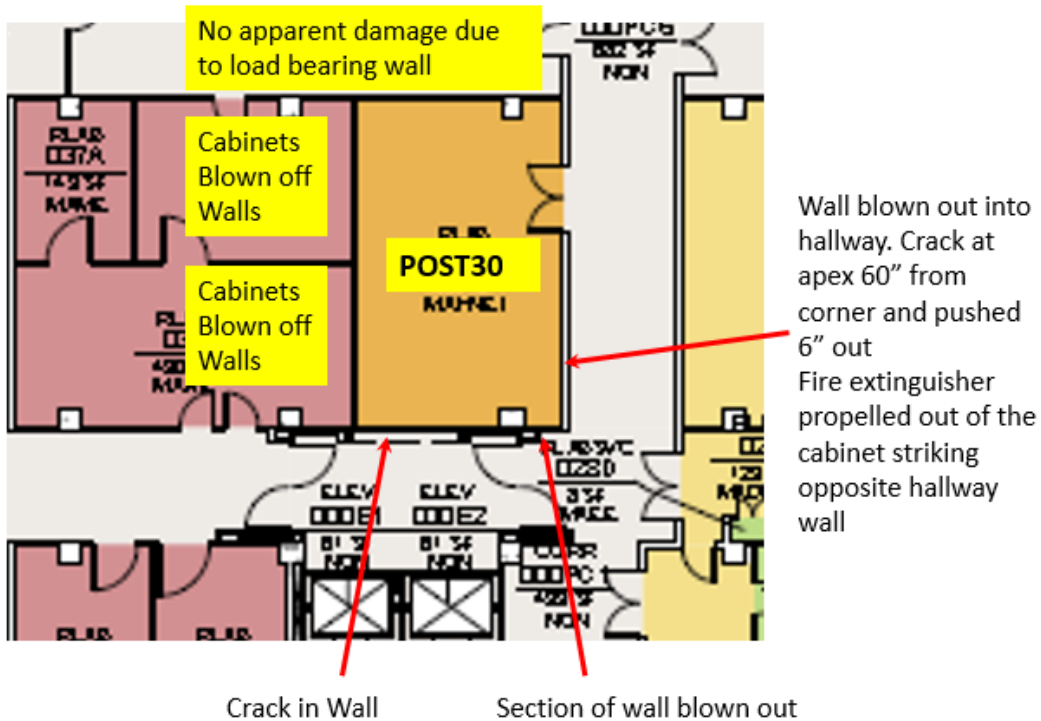

Figure 20: Major damage to Post 30 room walls and adjacent laboratories and hallways.

⁴⁸Honolulu Fire Department

The biosafety cabinet took the full force of the pressure wave. The glass sash completely shattered, the right side wall was severely deformed and the top panel was blown up and off (Figure 18). Green paint from the gas storage tank was found on the top panel. The second postdoctoral researcher's oxygen cylinder was blown against the wall (Figure 21). Fortunately, the regulator faced away from the wall when the cylinder hit as there was a significant chance for the brass cylinder valve to have been sheared off. Nevertheless, the force of the impact compressed the cylinder's regulator spring causing an overpressure and spinning of the gauge. The polyethylene tubing attached to this oxygen cylinder was severed at the compression connection and the cylinder emptied into the lab. It was also fortunate that, an oxygen enriched fire did not occur due to this release. Testing by Airgas (the supplier) after the incident confirmed that the second postdoctoral researcher's oxygen cylinder was empty and that the oxygen cylinder used by the postdoctoral researcher to fill the gas storage tank had approximately 1750 psig indicating that the cylinder was closed after usage⁴⁹.

During the POST 30 laboratory cleanup, several gouges, (some about 2 inches in diameter,) were found in the floor in front of the biosafety cabinet (Figure 22) and autoclave. The gouges were likely caused by the exploding gas storage tank legs and other attachments (i.e. handle, ASME plate) confirming its position where predicted in Figure 8.

A summary map of the effects of the explosion is shown in Figure 23. This gives the best approximation of the facts that the Investigative team could assemble. The accident scene was significantly disturbed prior to the Investigative Team's arrival. First, a hazardous waste company was brought in to clean up all the human tissue from the laboratory. In addition, a structural engineering investigation was necessary to ensure the structural integrity of the building support column located behind the autoclave. That required floor to ceiling removal of the drywall covering the column. These activities resulted in quite a bit of movement of items in the area making it more difficult to determine exactly where the gas tank was located at the moment of explosion.

⁴⁹ Gas cylinders are typically filled to 2,400 psig.



Figure 21: Oxygen cylinders used to fill the gas storage tank (standing upright) and used for the second postdoctoral researcher's ongoing experiment (tilted). The latter oxygen cylinder was open at the time of the explosion.

Observations regarding the oxygen cylinders⁵⁰ in the POST 30 laboratory:

- Both oxygen cylinders were strapped to the biosafety cabinet with a safety strap as required by OSHA⁵¹ and CGA P-1⁵². However, the safety straps of both cylinders loosened as a result of the force of the explosion. Although not required by HIOSH, chaining gas cylinders presents a safer option.
- One of the oxygen cylinders was open when the explosion occurred and vented its gas content into the laboratory. However, it did not cause an oxygen enriched fire which would have led to more damage and possibly cause the adjacent oxygen cylinder that was closed to vent through the CG-1 (Rupture disk) pressure relief device.

⁵⁰ For guidelines see also Appendix D and E.

⁵¹ 29 CFR 1926.350(a)(9) Compressed gas cylinders shall be secured in an upright position at all times except, if necessary, for short periods of time while cylinders are actually being hoisted or carried.

⁵² Compressed Gas Association (CGA) Standard P1: Safe Handling of Compressed Gasses; <https://law.resource.org/pub/us/cfr/ibr/003/cga.p-1.1965.pdf>; accessed 6/8/2016.

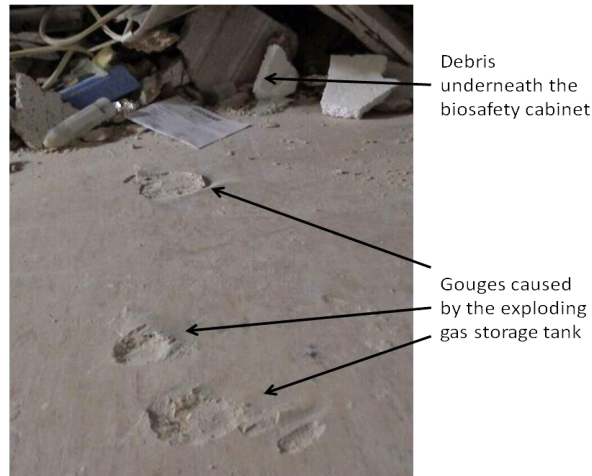

Figure 22: Gouges on floor caused by the exploding gas storage tank near the biosafety cabinet.

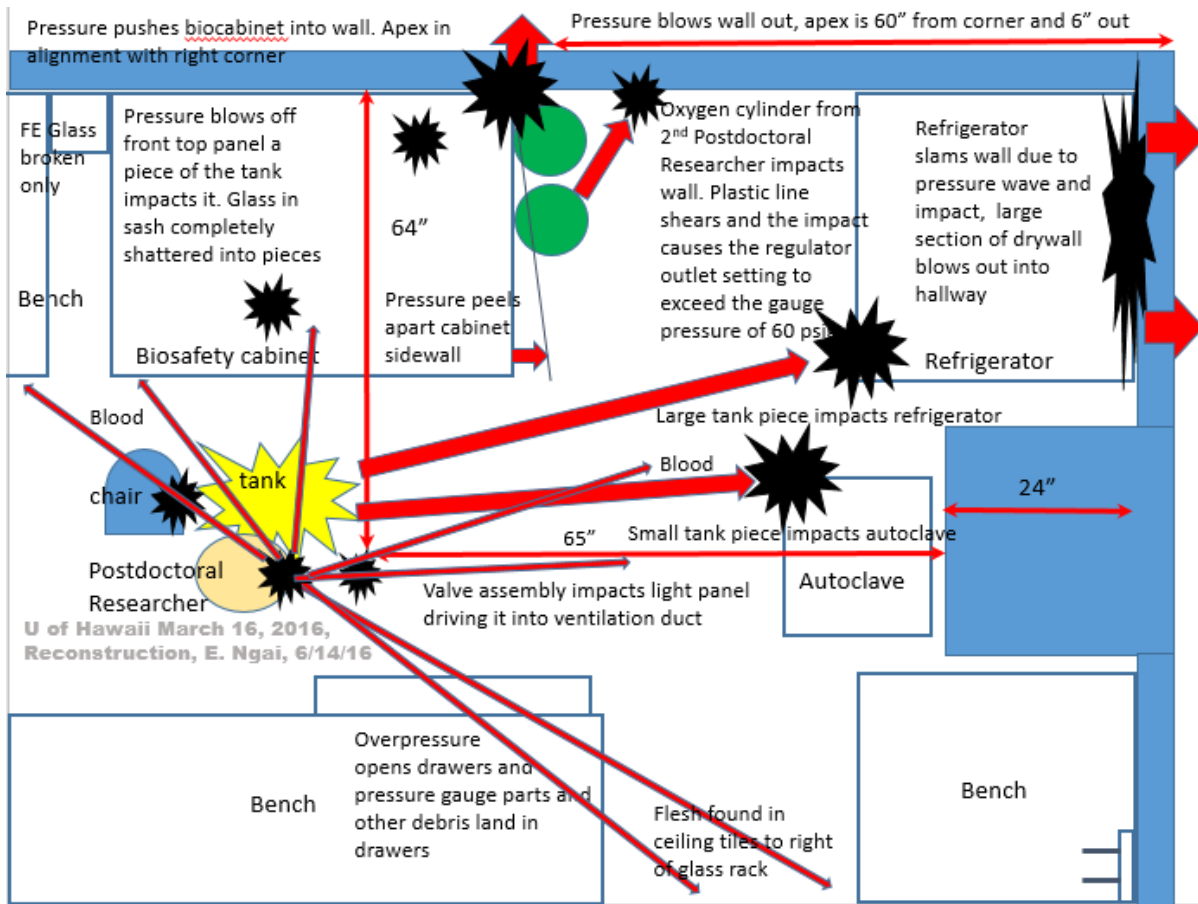

Figure 23: Summary map of the explosions effects.

Potential Causes of the Storage Tank Rupture

Pressure vessels can rupture for a number of reasons. Based on visual inspection and forensic testing, the gas storage tank rupture does not appear to be a physical failure, but a detonation of the explosive gas mixture within the tank.

The following is a summary of potential causes for the rupture of the gas storage tank which were evaluated. The Investigative team does not consider any of the potential causes detailed below to be the cause of this accident.

1. **Overpressure** – An ASME pressure vessel is designed for a minimum overpressure of 3 times MAWP. This means that the 13 gal tank which has a MAWP of 168 psig should hold a minimum pressure of 504 psig without rupturing.

The gas storage tank's pressure relief device was marked 168 psig. ASME Section VIII for unfired pressure vessels requires a single Pressure Relief Device (PRD) protecting an ASME code stamped pressure vessel to be set at or below the MAWP. The maximum accumulation pressure allowed in the vessel when the PRD is relieving full open is 110% of MAWP during a fully engulfing fire or upstream equipment failure.

The pressure regulators on the gas cylinders for the individual high pressure gases (H₂, CO₂ and O₂) had maximum outlet pressures of 200 psig. Therefore, it would not have been possible to over-pressurize the gas storage tank even at maximum setting of the cylinder's regulators.

An overpressure of a pressure vessel would typically cause a single tear releasing the pressure, remaining in one piece. The gas storage tank was violently ripped apart.

2. **Corrosion** – The tank had only been used for 3 months. There was slight interior surface corrosion that may have been due to hydrotest water remaining inside the tank after fabrication. Carbon dioxide will form carbonic acid with any liquid water. Carbonic acid will corrode the carbon steel forming pits or pinholes. Visual examination of the interior surface showed no evidence of corrosion. The tank's exterior was painted and also showed no visible signs of corrosion.
3. **Hydrogen Embrittlement** – Hydrogen embrittlement of with low alloy carbon steel pressure vessels can occur when it is stressed at high pressures⁵³. The maximum use pressure for the gas storage tank of 120 psig is well below the MAWP of 168 psig. The presence of O₂ or H₂O will inhibit the embrittlement⁵⁴. The presence of trace amounts of H₂S or HCl in hydrogen can also catalyze the formation of the atomic hydrogen required for embrittlement to occur. Hydrogen embrittlement generally causes intergranular fracture, which manifests itself as jagged cracks along grain boundaries within the metal. An example of this is shown in Figure 24. This failure occurs when the carbon in the carbon steel reacts with hydrogen, leaving a void. Visual examination of the tank fragments where it tore apart showed no intergranular fractures (jagged

⁵³ ISO/CD 11114-1 Transportable Gas cylinders – Compatibility of cylinder and valve materials with gas contents – Part 1 : Metallic materials"

⁵⁴ ISO 11114-4 Transportable gas cylinders — Compatibility of cylinder and valve materials with gas contents — Part 4: Tests methods for selecting metallic materials resistant to hydrogen embrittlement

edges). In addition the section of the tank that wrapped inward did not have multiple cracks that would have been revealed when the metal flexed in the opposite direction. As evidenced by the sharp edges, the tank appears to have been torn rather than cracked.



Figure 24: Cylinder embrittlement; note jagged edge and interior surface cracks⁵⁵

4. **Low Temperature Embrittlement** – Carbon steel embrittlement can also occur at temperatures below -30 °C. There was nothing in the laboratory that could have exposed the gas storage tank to extremely low temperatures. Visual examination of the tank fragments showed no intergranular fractures. The tank appears to have been torn rather than cracked.
5. **High temperature embrittlement** – Temperatures between 400 and 600 °C can cause hydrogen embrittlement. No signs of any heat damage to exterior paint were observed which would bubble then char before embrittlement occurs.
6. **Stress Corrosion Cracking (SCC)** – Specific degradation of gas tanks from stress corrosion cracking can occur due to the presence of CO, CO₂ and liquid H₂O. All three must be present for this to happen. The use pressure was low in comparison to the MAWP, therefore, the tensile load was low. SCC failure is similar to H₂ embrittlement. Visual examination of the tank fragments where it tore apart showed no intergranular fractures (jagged edges). In addition the tank section that wrapped inward did not have multiple cracks that would have been revealed when the metal flexed in the opposite direction.⁵⁵ The tank appears to have been torn rather than cracked
7. **Weld Failure** – A bad weld can cause the tank to rupture. If this was the case the tank would have ruptured at the weld but stayed in one piece.
8. **Physical Flaws** - Physical flaws such as cracks or inclusions can occur during fabrication of the tank. None were observed and while the tank disintegrated along some weld seams, this failure was due to the lower strength at these points. Visual examination based on CGA Pamphlet C-6 Standard⁵⁶ for Visual Inspection of Steel Compressed Gas Cylinders showed no visual problems with the tank.

⁵⁵ Ngai, E., "Dangerous Gas Mixtures: Avoiding Cylinder Accidents" Specialty Gas Reporter, 2nd Qtr 2014

⁵⁶ Standard for Visual Inspection of Steel Compressed Gas Cylinders; <https://www.cganet.com/customer/publication.aspx>; accessed 6/8/2016.

9. **Physical Damage** - Punctures, dents, and gouges can compromise tank integrity. Visual examination as per CGA C-6 did not show any signs of this. No external physical damage was identified other than the damage that was the result of impacting the refrigerator, autoclave and other surfaces.
10. **Fatigue due to loss of elasticity** – The tank had been recently purchased and it had only been filled eleven times, therefore, fatigue due to loss of elasticity is unlikely. The use pressure of 90-120 psig is well below the maximum allowable working pressure of 168 psig. Loss of elasticity occurs when the MAWP is exceeded causing a loss in ductility.

Potential Causes of the Gas Mixture Ignition

Reaction of the Gas Mixture – Given the extent of physical damage to the Laboratory as well as to the gas storage tank containing an explosive gas mixture at high pressure, the event was caused by a reaction of the explosive gas mixture.

The originally intended gas mixture used for the gas storage tank was 70% H₂ : 20% O₂ : 10% CO₂; however, gas mixtures were constantly adjusted to fit experimental needs. At the time of the explosion, the gas mixture in the gas storage tank was 55% H₂ : 38% O₂ : 7% CO₂ (Table 1). Both gas mixtures are clearly in the explosive range and near stoichiometric concentrations promoting a reaction between the two gases and increasing the risk of explosion (Figure 25).

At 20% O₂, the stoichiometric amount of H₂ to react to form H₂O would be 40%. This makes the explosive mixture in the gas storage tank (70% H₂ : 20% O₂ : 10% CO₂) fuel rich (Figure 25). The estimated energy release would be 3.88 grams TNT per g of H₂.⁵⁷ Although slightly in the fuel lean area, the estimated energy for the hydrogen/oxygen gas mixture contained in the tank⁵⁸ at the time of detonation was approximately the equivalent of 70.5 grams of TNT. This energy can increase dramatically as it becomes oxygen enriched, in abundant oxygen the energy would have been almost 10 times greater.

Due to the low ignition energy (<0.02 millijoules) these hydrogen/oxygen mixtures can be easily ignited in a wide variety of ways. NFPA 53 table F.2.1 reported an even lower ignition energy of 0.0012 millijoules when H₂ is mixed with O₂.⁵⁹ These levels are well below perceptible levels of 1 mJ that a human can feel.

⁵⁷ Werley, Barry L., Hansel, James G., Buchter, William C., "TNT Equivalency Concepts", Spring 1998 ASTM G-4 Seminar, April 1998, Atlanta, GA

⁵⁸ 9.09 mol of H₂ assuming a temperature of 70°F (21.1°C)

⁵⁹ NFPA 53: Recommended Practice on Materials, Equipment, and Systems Used in Oxygen-Enriched Atmospheres, 2016 Edition
Page 34

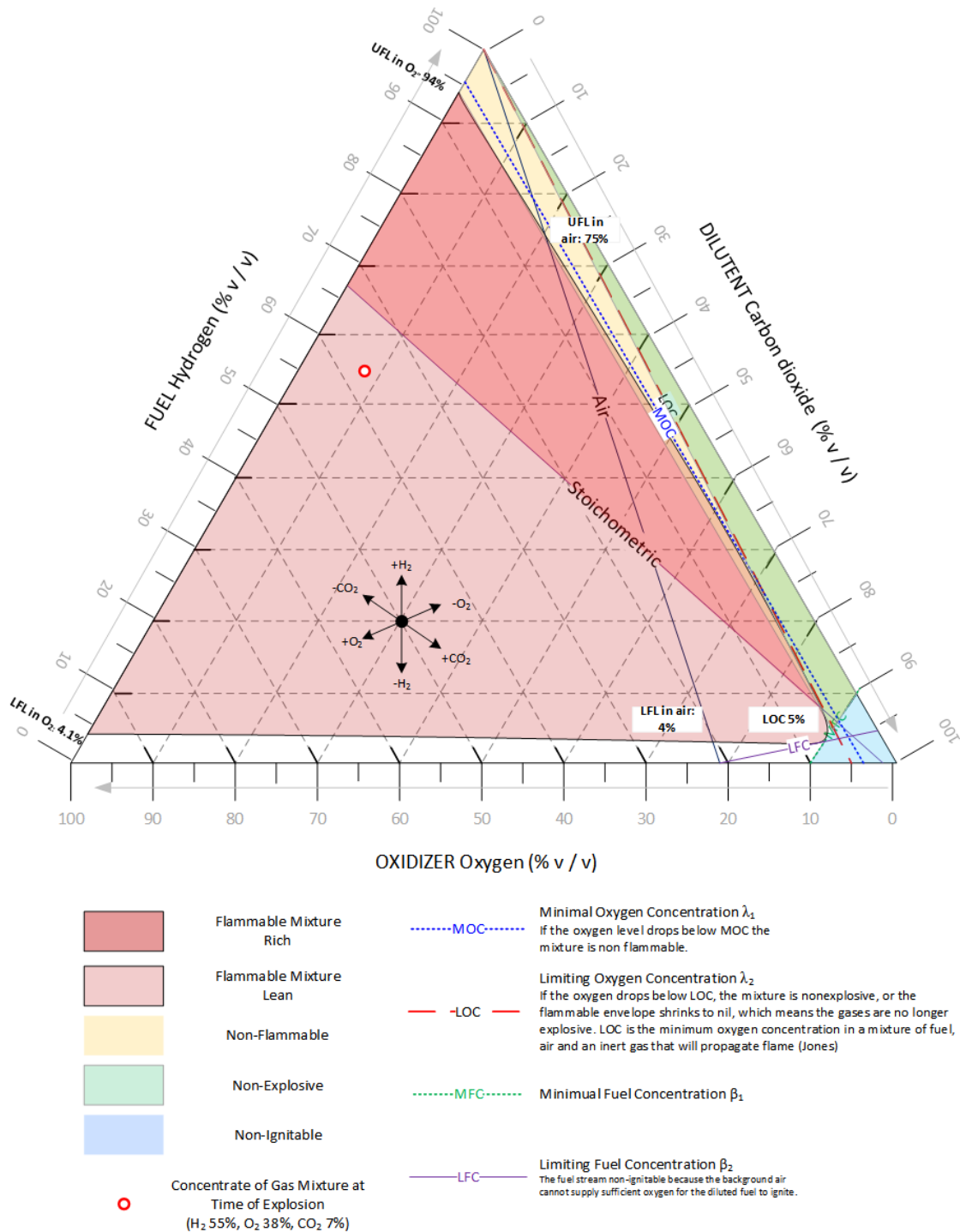

Figure 25: Fire diagram for hydrogen/oxygen gas mixtures. Flammability diagrams show the regimes of flammability in mixtures of a flammable and oxidizer gas diluted with an inert gas such as carbon dioxide that was used in the

experiments in the UH lab⁶⁰. The red circle indicates the gas mixture at the time of the explosion, 55% H₂ : 38% O₂ : 7% CO₂. LFL, Lower Flammability (or explosibility) Limit; UFL, Upper Flammability Limit.

The flammability diagram above shows a 3 gas mixture (H₂, O₂ and CO₂⁶¹) and the limits of flammability at various concentrations. To use this diagram, the H₂ concentration is selected on the left side and then the O₂ concentration from the bottom. The intersection of the two would then be the CO₂ concentration on the right. This mixture is well in the flammable envelope and is oxygen enriched which will detonate with considerably more force than a stoichiometric concentration as noted earlier.

Based on statements made by the injured postdoctoral researcher to the Honolulu Fire Dept Investigator, the ignition of the gas mixture occurred during the actual and the near miss event when she pressed the pressure gauge On/Off button. Other likely ignition sources are summarized here for reference. During the life of the gas mixture in the tank, any one of these could have ignited the mixture:

1. **Adiabatic compression** – This occurs when a gas is compressed adiabatically which could have occurred when the postdoctoral researcher opened the HAM-LET ball valve pressurizing the PE transfer tubing. If a gas obeys the ideal gas laws, then compressing it at constant entropy would increase the temperature. In many high pressure explosive gas incidents, this has been the most likely source of ignition. At a pressure of 90 psig the temperature increase is estimated to be 453 °F (254 °C) which is well below the gas mixture autoignition temperature of 752 °F (400 °C) and therefore not the likely cause. The ball valve as noted earlier was closed.
2. **Shock Wave** – An uncontrolled release of hydrogen/oxygen to the atmosphere can create a shockwave that will ignite the mixture. Researchers demonstrated that ignition occurred when high pressure hydrogen was suddenly admitted to a shock tube filled with air or oxygen⁶². Since the valve was closed this was not the likely cause.
3. **Physical Impact** – Explosive gas mixtures have been shipped bouncing around the back of a truck for thousands of miles without ignition. In 1988 a high pressure cylinder containing an explosive gas mixture of silane (SiH₄) and nitrous oxide (N₂O) mixture was shipped from Pocatello, ID, to Newark, CA, and finally to Berkeley Heights, NJ, but did not ignite (over 3,000 miles of handling)⁶³. An explosion occurred when the cylinder valve was opened to dispose of the gas mixture at the Gollub Analytical Laboratories in Berkeley Heights, NJ. The explosion killed 3 people and disabled a fourth. Testing of explosive gas mixtures in cylinders to meet transportation safety requirements have demonstrated that physically impacting a cylinder with a weight or dropping it from a height will not trigger the ignition. Even bullet penetration of the cylinder did not trigger the ignition⁶⁴. Therefore, physical impact as a trigger is generally considered to be highly unlikely.
4. **Particle Impact** – Particles suspended in the gas stream from tank can release enough energy upon impact. Particles larger than 30 micron in size can provide sufficient energy in an O₂

⁶⁰ See https://en.wikipedia.org/wiki/Flammability_diagram

⁶¹ While it has a higher thermal conductivity, CO₂ is an inert gas and will behave similar to N₂ in the case of the explosive mixture.

⁶² Wolanski, P.: Mechanism of synthesis gas explosion during outflow from high pressure installation. *Chemik Rok XXV*(1), 23–27 (1972)

⁶³ NJ Star Ledger, March 18, 1988, pg 1

⁶⁴ Blumenthal, J. L. and Stansel, J. C. "The Heated Gas Inflator-A New Paradigm in Airbag Technology" Proceedings of the Eighth International Pacific Conference on Automotive Engineering, Volume 2, Pacific Convention Plaza Yokohama, Japan, November 4-9, 1995, pg 347-352

enriched explosive atmosphere to cause ignition⁶⁵. Systems that have not been properly cleaned and filtered can contain considerable quantities of particles.⁶⁶ There was no gas flow prior to the explosion so ignition by particle impact is considered to be unlikely.

5. **Flow Friction** – a partially open ball valve can create flow friction as a result of high velocity compressible flow igniting the mixture.⁶⁷ However, the gas storage tank had already been filled with the gases before the explosion occurred and there was no gas flow immediately prior to the explosion from the cylinder that the postdoctoral researcher was using.
6. **Rust** – Rust was found on the gas storage tank's interior (Figure 5). The possibility of iron oxide catalyzing a reaction between hydrogen and oxygen was examined by exposing hydrogen/oxygen mixtures at 1.1 MPa (160 psig) and various temperatures to iron oxide⁶⁸. No reaction occurred at ambient temperatures as measured as a decrease of pressure as hydrogen and oxygen condensed. Only after 24 h at 100°C (212°F) iron oxide catalysis of gas condensation could be determined. Therefore, rust is not suggested to play a major role in an explosion event at ambient temperatures.
7. **Pressure Gauge Electrical Discharge** – Based on the postdoctoral researcher's statements, an electrical discharge of sufficient energy to ignite the explosive gas mixtures contained in the incubator and the gas storage tank may have occurred twice with two different battery operated digital pressure gauges from Ashcroft. The incubator gauge that was involved in the near miss and the exemplar Ashcroft gauge were tested for electrical leakage under a variety of conditions. No electrical leakage was found while pressing the On/Off button; it was the same for pushing the backlight button on and off. However, an errant electrical charge cannot be excluded.

Causality of the Detonation

Honolulu Fire Department Report

The Honolulu Fire Department investigated the accident and concluded their investigation on March 30, 2016. They examined the lab on two occasions and also were able to speak to the injured postdoctoral researcher as well as the principal investigator. Their main conclusions were:

- The accident was an explosion and not a fire
- The explosion was accidental
- The cause (ignition source) was the Ashcroft digital pressure gauge which was not rated intrinsically safe

Quoting the Investigation Summary Report:

"The accidental cause of this explosion was caused by the detonation of compressed gases to include: Hydrogen, Carbon Dioxide, and Oxygen with the air tank. A digital pressure gauge used

⁶⁵ ASTM G63 "Standard Guide for Evaluating Nonmetallic Materials for Oxygen Service".

⁶⁶ Martrich, R, Slusser, J.Lievre "Recognising and addressing the hazards of oxygen enrichment", Glass Worldwide, Issue twenty one 2009, pg 33

⁶⁷ <http://www.fda.gov/MedicalDevices/Safety/AlertsandNotices/PublicHealthNotifications/ucm062088.htm>

⁶⁸ Mr. J Gummer & Dr. S Hawksworth, Spontaneous Ignition of Hydrogen Literature Review, 2008, HSE Books, <http://www.hse.gov.uk/research/rrpdf/rr615.pdf>, accessed 6/9/2016.

to check the pressure within the tank was not rated or designed (not intrinsically safe) to be in a flammable gaseous atmosphere. When the OFF button was pressed, an electrical arc/spark created within the gauge detonated the flammable gas within the tank causing the explosion.”

The HFD investigator further suggested:

“It is my recommendation that all items of interest (tagged and untagged) in the area of fire origin, and/or at the identified/probable point of fire origin, be further examined by a certified forensics laboratory or other certified authority.”

While the Ashcroft digital pressure gauges involved in both the near miss incident and the gas tank explosion were not rated as intrinsically safe (Ashcroft does sell intrinsically safe versions) the Investigative Team has concluded that this was not a factor in the ignition of the explosive gas mixture.

The Ashcroft digital pressure gauge⁶⁹ employs a thin pressure diaphragm made of 17-4 PH stainless steel where strain sensors are attached which are employed to determine the gas pressure (Figure 26). This is the “wetted” material that came into contact with gas mixture inside the tank⁷⁰. Under high temperatures hydrogen can permeate through the steel diaphragm. Testing by WHA International demonstrated that the diaphragm left on the stem from the pressure gauge on the gas tank was gas leak tight under Helium pressure. Similarly, the diaphragm on an identical new Ashcroft pressure gauge was also leak tight. Threading of the pressure gauge stem into the gas tank bushing, and the bushing into the gas tank, were leak tested by the postdoctoral researcher. Therefore leakage of the explosive gas mixture into the body of the pressure gauge where it was ignited by the electrical circuitry did not occur.



Figure 26: Pressure gauge diaphragm still attached to the threaded gauge stem that was still threaded into a bushing on the tank. On the external surface (non-wetted side) of the diaphragm one can see markings where the strain sensors were attached to the diaphragm.

⁶⁹ Model 2174 (4-20 loop)

⁷⁰ http://www.bricebarclay.com/PDFs/Ashcroft_Digital_Pressure_Gauge_Manometer.pdf

Physical evidence shows that the pressure gauge from the tank came apart in multiple pieces. HFD Fire Investigator stated that when he visually inspected the pressure gauge metal housing that evening and it did not appear to be severely damaged due to physical impact (Figure 27).



Figure 27: Pressure gauge housing as found by HFD

The investigator stated that the bottom where it was connected to the sensor diaphragm on the tank was mushroomed. As seen in Figures 14 and 15, the gauge was severed at the mushroom which housed the pressure diaphragm.

The gauge housing and the tank valve assembly were ripped out of the tank as the large piece of the tank was rupturing. The pressure gauge face plate and circuit board is held onto the housing by a small screw. This was severed when the pressure gauge housing was ripped from the tank. Pieces of the pressure gauge were found in cabinet drawers, countertop and the floor along with other debris (Figure 28). Unfortunately the housing that appeared to contain the batteries and the remote readout wires was not available for examination.

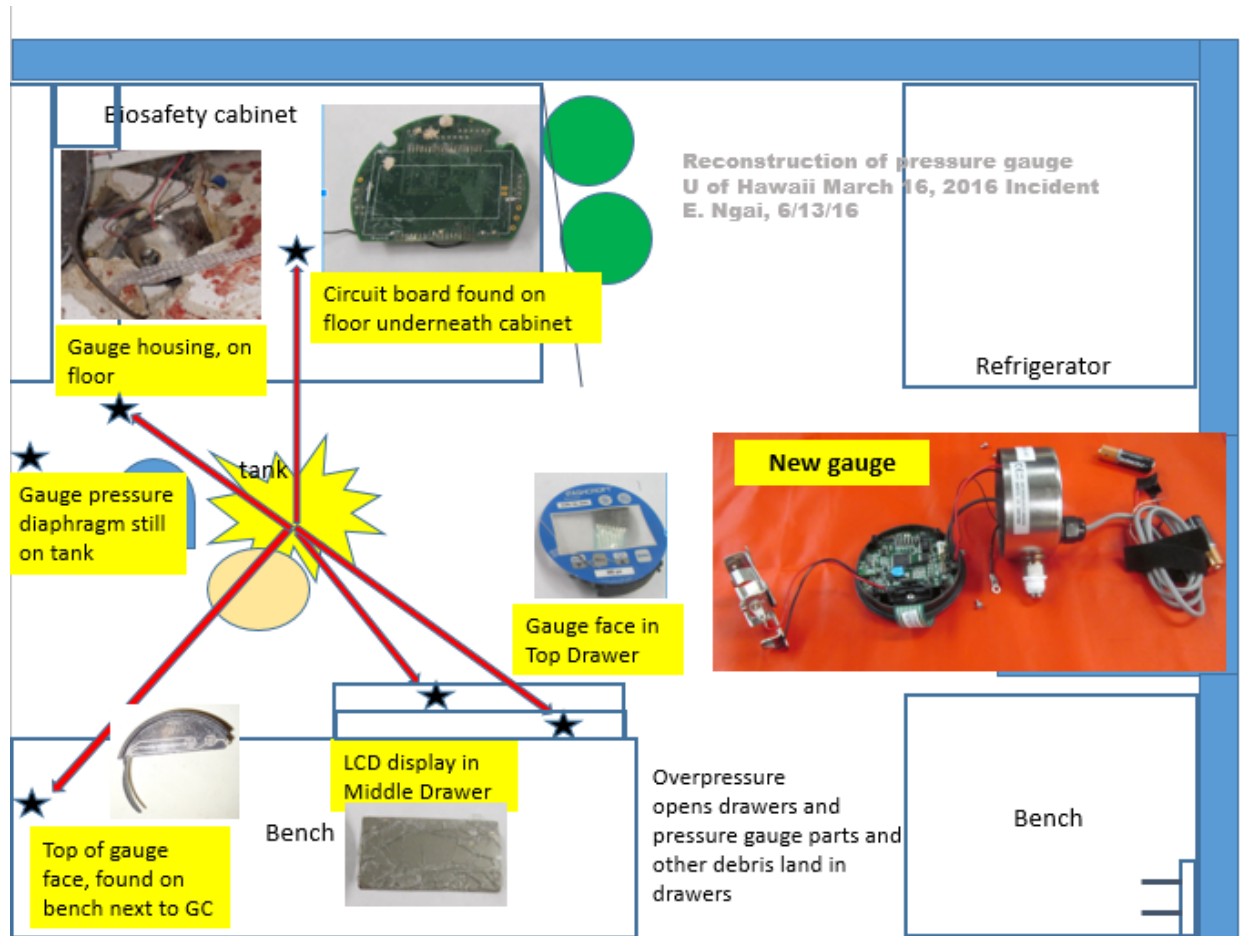

Figure 28: Location of gauge components found after the gas tank explosion.

Forensic Examination and Testing

For root cause analysis of the explosion, the gas storage tank and its components were forensically examined at the WHA International laboratory in Las Cruces, NM, on May 23 and 24, 2016. An identical gas storage tank and its accessories were purchased including a digital Ashcroft gauge (300 psig), a HAM-LET ball valve and Teflon tape, all identical to those involved in the accident. The gas storage tank and its components were assembled according to Figure 3. The assembled “Exemplar” gas storage tank is shown in Figure 29.

Other items for forensic examination were formally received from UH that originated from the POST 30 lab. They included the stem of the Ashcroft (300 psig) gauge, the stem of the damaged HAM-LET ball valve, an Ashcroft gauge (100 psig) that was found on the pressure vessel (bacterial incubator) involved in the Near Miss event, and an Ashcroft gauge (100 psig) that was located on the bench opposite the

biosafety cabinet (Figure 8). All original items were inspected and logged in under strict chain of custody protocols.

Examination of all components was non-destructive and based on a test protocol (TP-WHA-16064-0-A-EX2) agreed upon by the Investigative Team, UH and WHA International. The testing was videotaped in its entirety. See Appendix F.

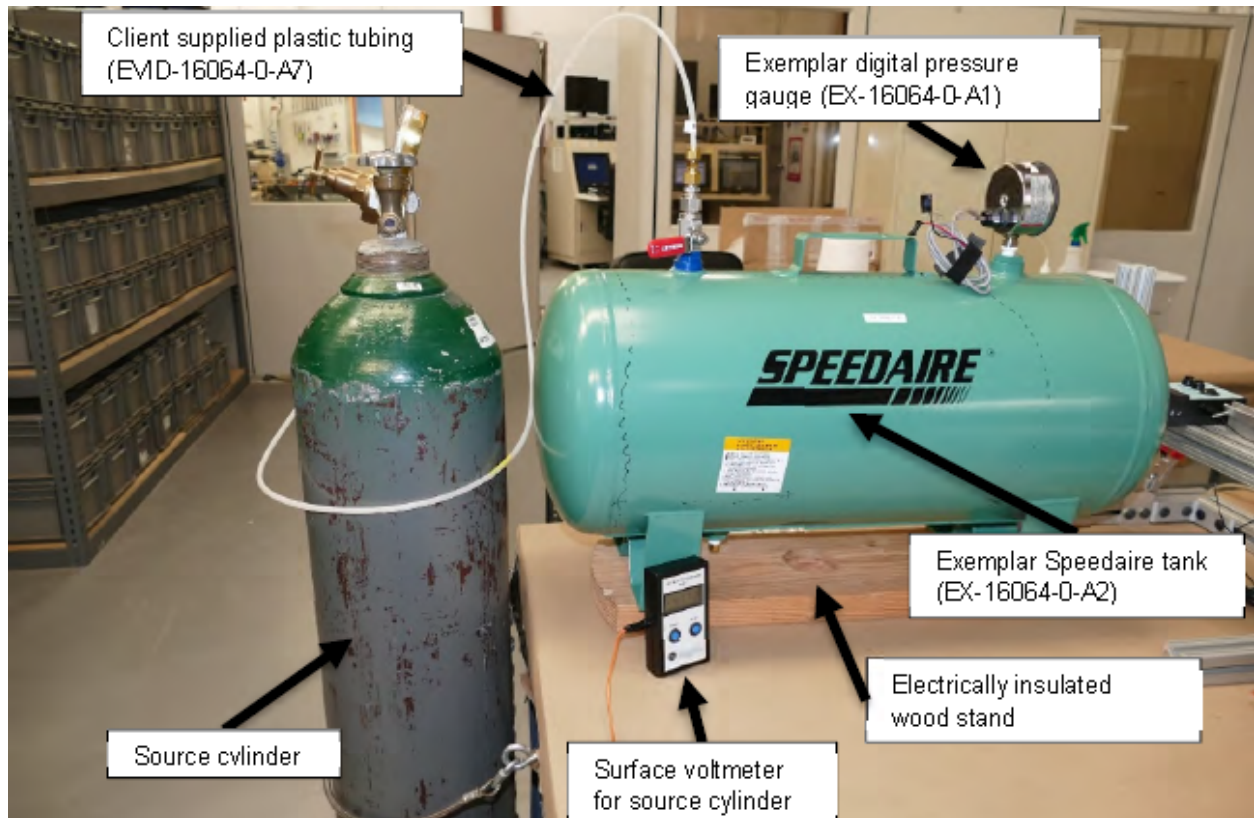

Figure 29: Exemplar tank and attachments used in testing.

To test the many theories as to what could have caused the ignition, the experimental setup illustrated in Figure 30 was used with the Exemplar tank shown in Figure 29. The entire system was electrically insulated in order to measure any electrical leakage or charge accumulation.

The pressure gauge diaphragm was microscopically examined and there appeared to be no physical damage to the surface. It was installed on the exemplar tank and pressurized with helium to 120 psig. A thermal conductivity gas leak detector with a sensitivity of 10^{-5} cc/sec helium leak rate was used to “sniff” around the diaphragm and threads. No leak was found despite the physical trauma it experienced. The operation of the leak detector was confirmed when it was used at the ball valve assembly reducing bushing which leaked at the same location as was reported with the POST 30 tank. The surface of the diaphragm appeared to have a clear coating and was electrically non conductive.

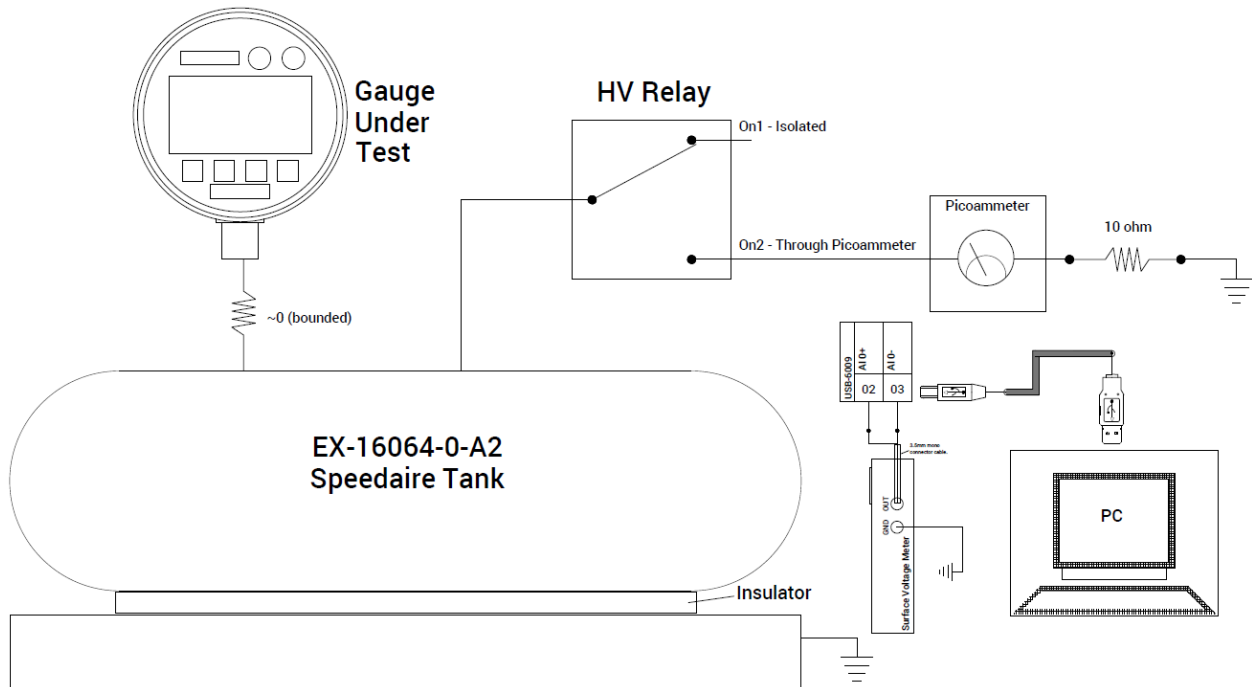

Figure 30: Simplified Surface Voltage and Current-to-Ground Measurement Setup

As stated by the HFD report, when the postdoctoral researcher pressed the On/Off switch on the digital pressure gauge the tank exploded. She also grounded herself on the metal housing when she did this. This triggered a deflagration of the explosive mixture that propagated down the tank and very rapidly reached detonation at the opposite end, blowing out the end piece and tearing the tank horizontally.

The leading theory on the cause of the ignition was that a corona or brush electrical discharge was created internally at the pressure gauge stem due to the electrical charge transfer.

Grounding and Bonding

When handling flammable gases or explosive gas mixtures proper grounding and bonding are critical safeguards to prevent an electrical discharge that can ignite the flammable or explosive gas mixture. CGA G5.4 – 2012 edition Standard for Hydrogen Piping Systems at User Locations, 5th edition under section 5.5 states the equipment and piping shall be bonded and grounded to drain static electrical fault currents to earth ground.

Testing of the exemplar POST 30 tank and attachments revealed:

1. The HAM-LET ball valve handle and ball was electrically isolated from the tank
2. The tank could not easily be grounded because of the paint. The paint proved to be a good insulator, testing at 1,000 V yielded a resistance of >2.2 gigaohm (GΩ). To properly ground the exemplar tank, the paint on one of the tank legs was removed to bare metal and a metal bolt was used to attach the ground wire.

3. The only surfaces that conducted any electrical discharge were the HAM-LET ball valve body and the Ashcroft gauge metal housing. The tank handle and the gauge face did not conduct
4. The pressure relief valve and drain plug which are bare metal were also electrically conductive.
5. The polyethylene tubing used to transfer gases into the gas storage tank were non conductive.

As a result, the gas storage tank was an electrically isolated island that could have held an electrical charge for some time before suddenly discharging when grounded. Testing revealed that electrical charges were readily conducted from a person to the tank or the tank to the person.

Being able to take apart or cut open the pressure gauge diaphragm and the ball valve assembly would have allowed further examination to confirm or refute the many theories on what caused the ignition. Excessive Teflon tape on tapered NPT connections have also been found to electrically insulate a system. .

Pressure testing of the pressure gauge from the incubator against a NIST traceable pressure gauge proved that it was still functional and accurate up to 100 psig which is the maximum range of the gauge. If the gas mixture had detonated rather than deflagrated, it would have mechanically damaged the gauge. The gauge was also leak tested with Helium at a pressure of 95 psig using a helium leak detector with a sensitivity of 10^{-5} scc/sec. No leaks were found.

Likely Cause of Detonation

The Investigative Team's ability to determine the initial cause for the detonation was challenged by the fact that they were not able to inspect the accident scene until 13 days later. By that time much of the area was disturbed due to other investigators⁷¹ entries into the laboratory room, by actions of the building structural engineer and risk manager, and the actions of a hazardous biological cleanup company to clean and sanitize blood spatter and other body parts which were widely scattered. The Investigative Team had to rely on photos taken by others to visualize the scene immediately after the explosion. In addition, they were not able to interview the postdoctoral researcher and had to rely on the HFD Investigators' comments and report. Destructive examination of the evidence was also not authorized by UH legal counsel. Being able to take apart or cut open the pressure gauge diaphragm, ball valve assembly would have allowed further examination to confirm or refute the many theories on what caused the ignition.

Based on the unconfirmed statement by the injured postdoctoral researcher and the other evidence the Investigative Team also concluded that the Ashcroft digital pressure gauge was the origin of the electrical current that caused the detonation of the hydrogen/oxygen gas mixture contained within the gas storage tank. For this to occur, an electrical current of minimal energy would have to be transferred into or out of the tank creating a corona or brush discharge at the pressure gauge stem. Forensic examination and testing of the pressure gauge was conducted to determine the means by which this could have occurred.

⁷¹ Honolulu Fire and Police Departments

Static Discharge

Electrostatic charges can be easily generated and stored within a system or person. These are discharged when they are grounded.

Human static discharge - Human static discharge that one can barely perceive is 1 millijoule (mJ) of energy (Table 2). The charge that can be generated is strongly influenced by the humidity and the types of clothing that the researcher was wearing. The humidity in Honolulu is typically above 45%, which would prevent a large static charge from accumulating or provide a ground to for the charge to slowly dissipate. Facilities Engineering indicated that the humidity in POST 30 was typically at 65%; in fact, mold issues were reported in the building. Even at 65%-90% humidity a person can still generate a small static charge of 1-2,000 volts versus the tens of thousands of volts in a less humid environment as noted in the table above⁷².

Table 2: Physiological responses to various levels of electrical discharge energy⁷³.

Electrical Discharge Energy	Physiological Response
1 mJ	Perceptible
10 mJ	Prick
30 mJ	Sharp prick
100 mJ	Slight jerk
250 mJ	Severe shock
>1 J	Possible unconsciousness
> 10 J	Possible cardiac arrest

⁷² - Bergeron, B.P., ESD-Electrostatic Discharge-Part 1, QST, April 1991, pg 19-21

⁷³ Recreated after Table 22.4 from SFPE Handbook of Fire Protection Engineering, Springer Publishing

Because the postdoctoral researcher and others had reported experiencing static electricity within two months of the accident, a human static discharge was created at the forensic testing site. At the test site in New Mexico, the humidity was only 27% and a significant charge of >2,000 volts was generated by simply rubbing a polyester shirt against a leather seat. The Investigative Team attempted to create a static charge on their bodies on March 30 at University of Hawaii by shuffling on the conference room rug but no discernable charge was developed – most likely because of the relative high humidity of that environment (Table 3).

Table 3: Electrostatic Charge Generation Under Different Levels of Relative Humidity (RH).⁷⁴

Examples of Static Generation – Typical Voltage Levels		
Means of Generation	10-25% RH	65-90% RH
Walking Across Carpet	35,000V	1,500V
Walking Across Vinyl Tile	12,000V	250V
Worker at a Bench	6,000V	100V
Poly Bag Picked up from Bench	20,000V	1,200V
Chair with Urethane Foam	18,000V	1,500V

Using a Van de Graaff static generator a WHA engineer was charged to high voltage (4,000 V) and he then pressed the On/Off button of the Ashcroft gauge identical to the one used in the explosion (Figure 30). However, the engineer did not discharge until he touched the metal of the gauge housing. Therefore, the researcher pressing the On/Off button, as stated in the Honolulu Fire Department’s report, had to also touch the metal part of the gauge housing to cause an ignition if the researcher or tank was statically charged. Since the gas storage tank is so low to the ground, it is very likely she grabbed the housing to steady herself as shown in Figure 31.

⁷⁴ <https://www.esda.org/about-esd/esd-fundamentals/part-1-an-introduction-to-esd/>



Figure 31: WHA engineer testing static electricity discharge by simultaneously touching the pressure gauge housing and pressing the gauge's On/Off switch

The same could be said for the incubator. The gauge housing would have to be held in order for the postdoctoral researcher to depress the On/Off switch with enough force to turn it off.

Static Electricity from Ball Valve - Testing at the Investigative Team's forensic testing site showed that the ball in the valve that was damaged in the incident and the exemplar ball valve were electrically isolated from the tank because of the Teflon seals surrounding the ball. They both had high resistance to applied voltages of 500 and 1,000 V. The wiping action of the ball against the non conductive seals of a valve when it is opened or closed can create an electrostatic charge⁷⁵. The charge could arc in a discharge as the gap closes. However, repeated actuations of the HAM-LET ball valve by a WHA investigator holding only the plastic covered handle did not create the expected charge.

Electrostatic Charging of Gases-Pure gases such as carbon dioxide have negligible electrostatic charge. However, when particles are present O₂ ignition events due to flow friction have been reported.⁷⁶ Rapid vaporization of liquid carbon dioxide can generate a significant electrostatic charge. The sizes of these fields, as determined by experiments, can reach values of between 50 and 180 kV/m.⁷⁷This

⁷⁵ ASTM Standard G 88 – 05 Designing Systems for Oxygen Service 5.2.1

⁷⁶ Aditi Oza, A, Ghosh, S. Chowdhury, K., "Tribocharging of Particle Contaminants Evaluated as an Ignition Source in Oxygen-Enriched Environments", J. ASTM I, Vol. 6, No. 8 July 2009 doi:10.1520/JAI102317

⁷⁷ The risk of generating static electricity when using CO₂ as an inerting agent, European Industrial Gas Association Safety Newsletter, SAG NL 76/02/E

possibility was examined at the forensic testing facility using a 72" length of the ¼" diameter polyethylene tubing (the same as used in the UH lab) and high gas velocity.

The carbon dioxide gas flow created a static charge, which was not reproducible. In order to generate a charge the liquid carbon dioxide in the cylinder must undergo rapid boiling causing it to aerosolize as large liquid droplets that flash vaporizes through the non conductive tubing. The electrically charged CO₂ would have remained in the gas mixture until it was discharged through the postdoctoral researcher when she touched the pressure gauge body. This is one of the likely sources of the ESD that caused the ignition.

Whatever caused the energy that was released igniting the gas mixture, the event occurred twice in the UH lab. Using a different model of the Ashcroft gauge and a 1 gallon pressure vessel (incubator for bacterial cultures) the postdoctoral researcher caused a small explosion when she pressed the gauge's On/Off button. Again, neither the researcher nor the vessel was grounded. Tragically, a root cause analysis of this near miss event could have prevented the researcher's traumatic injuries.

Other interesting findings that could not be pursued included Teflon tape that appeared to be burnt and melted on the gauge sensor stem (Figure 32). There was also pitting observed. Without further examination by destructive and chemical analysis, no further conclusions can be made.



Figure 32: Photo of gauge stem Teflon tape that appears to be charred and melted.

Conclusions on the Accident Event and Cause

The Investigative Team concluded that the source of energy that initiated the detonation was a electrostatic charge accumulation that was discharged between the postdoctoral researcher to the gas storage tank or from the gas storage tank to the postdoctoral researcher causing a corona or brush discharge within the pressure gauge stem. We believe the same event occurred in the near miss event with the incubator. Neither the postdoctoral researcher, the gas storage tank or the incubator were properly grounded, therefore allowing charge accumulation. The discharge occurred when the postdoctoral researcher touched the metal housing of the pressure gauge as she attempted to turn the gauge off.

A key finding was that the plastic face of the digital pressure gauge where the On/Off switch is located is electrically insulated. Since the postdoctoral researcher reportedly pushed the gauge's On/Off button when both incidents occurred, she could have only created a gateway for the electrostatic discharge

when she also touched the gauge metal housing, which is conductive (charge transfer). An alternative theory is that a stray electrical current within the digital pressure gauge circuitry could have caused an electrical transfer to the tank's interior. However, this process could not be recreated at the testing facility. No stray currents were measured within the exemplar gauge or on the 4-20 mA electrical leads used for remote readout. The pressure gauge from the incubator which caused the near miss was similarly tested and no stray currents were found that could have ignited the mixture. In addition, no gas leakage was found that would have introduced the explosive gas mixture into the non intrinsically safe gauge housing.

Based on the test results, the gas storage tank, a person, or the incubator are all perfect charge accumulators since they are so well insulated; a charge can be generated in many ways and stored until electrically grounded. Stray electrostatic currents were shown to travel into and out of the gas storage tank when the metal housing of the gauge or ball valve were contacted. These discharges caused the ignition during the charge transfer which created a corona or brush discharge. While these discharges are small, on the order of 1-10 millijoules (mJ), they are more than enough to ignite the explosive gas mixture which has a minimum ignition energy of 0.02 mJ.

Given the low energy required for ignition of the gas mixture, it is surprising that the incident did not occur earlier. In a less humid climate the range of conditions that can generate an electrostatic charge increase. For example, after the postdoctoral researcher filled the FEP gas sample bag with the explosive gas mixture she could have inadvertently rubbed it across a synthetic article of clothing she was wearing generating a significant charge. This could have discharged, ignited the mixture and exploded the gas sample bag while she was attempting to attach it to the gas chromatograph.

Other Accidents Involving Hydrogen

Three accidents involving hydrogen gas at university laboratories were reported recently, including a well-documented explosion that occurred on June 28, 2010 during the setup of an anaerobic chamber (glove box) in the Department of Biochemistry at the University of Missouri. The chamber, which normally should contain mostly nitrogen, was accidentally filled with hydrogen from a tank that was inadvertently left open after checking for gas leaks. Having reached explosive levels, a source inside the chamber ignited the gas⁷⁸. Four people were injured in this incident and one of them was hospitalized.

A hydrogen explosion in the Earth and Space Sciences Building at Stony Brook University injured one graduate student and one faculty on May 15, 2014.

On December 18, 2015, a postdoctoral researcher was killed in an explosion involving a hydrogen gas cylinder in a chemistry building at Tsinghua University in China⁷⁹.

In the industrial setting, a detonation at a fuel cell manufacturer in Sylmar, California in 2012 severely injuring two employees and involved the same company that had previously killed the owner's son in

⁷⁸ <http://munews.missouri.edu/news-releases/2010/0709-investigation-of-schweitzer-hall-explosion-complete/>

⁷⁹ <http://www.nature.com/news/postdoc-dies-in-lab-fire-at-tsinghua-university-1.19066>

2010 while experimenting with alternative hydrogen generation⁸⁰. Additional descriptions of accidental hydrogen explosions in non-academic facilities are described by Eugene Ngai⁸¹.

The Lessons Learned site at Hydrogen Tools describes 216 additional incidents involving hydrogen gas⁸².

Underlying causes for all hydrogen accidents including the explosion at the University of Hawaii include:

- Not recognizing the hazard of creating an explosive gas mixture
- Underestimating the risk involved
- Faulty engineering considerations of containers for hydrogen and hydrogen/oxygen gas mixtures
- Operational errors

The Investigative Team would like to thank the leadership of UH for their assistance, openness, and responsiveness during this investigation. In particular, we would especially like to recognize Dr. Michael Bruno, Vice Chancellor for Research, and Dr. Brian Taylor, Dean of the School of Ocean and Earth Science and Technology, for their outstanding leadership after the incident. There were many helpful staff who assisted in the investigation, but Hans Nielsen, EHSO Training Coordinator, should be commended for his remarkable responsiveness and professionalism.

⁸⁰ <http://www.dailynews.com/article/ZZ/20120209/NEWS/120209621>

⁸¹ Ngai, E., "Dangerous Gas Mixtures: Avoiding Cylinder Accidents" Specialty Gas Reporter, 2nd Qtr 2014

⁸² <https://h2tools.org/lessons/list>

APPENDICES

Appendix A: Initialisms and Acronyms

AIT	Autoignition temperature
APLU	Association of Public and Land-Grant Universities
ASME	American Society of Mechanical Engineers; ASME certification assures that a the design, fabrication, assembly, and inspection of boiler and pressure vessel components are done according to ASME specifications. The ASME stamp symbolizes quality control assures reliable allowable pressures.
ASTM	American Society for Testing and Materials
ATM	Atmospheres pressure
CDC	Centers for Disease Control and Prevention
CHP	Chemical Hygiene Plan
CGA	Compressed Gas Association
CSB	Chemical Safety Board
DOT	Department of Transportation
EHSO	Environmental Health & Safety Office
FEP	fluorinated ethylene propylene
GC	gas chromatography
GHS	Global Harmonized System
HFD	Honolulu Fire Department
HIOSH	Hawaii Occupational Safety and Health
HNEI	Hawaii Natural Energy Institute
ICF	International Fire Code
Investigative Team	The four investigators representing UCCLS for the investigation
MAWP	Maximum Allowable Working Pressure

mJ	Millijoules
NEC	National Electric Code
NFPA	National Fire Protection Association
NIST	National Institute of Standards and Technology
NPT	National Pipe Thread
PE	Polyethylene
PHA	Polyhydroxyalkanoate
PI	Principal Investigator
POST	Pacific Ocean Science and Technology building
POST 30	Basement laboratory room 30 in the Pacific Ocean Science and Technology building
PPE	Personal Protective Equipment
PRD	Pressure Relief Device
psia	Pounds per square inch absolute is the pressure is relative to a vacuum rather than the ambient atmospheric pressure. Psia = 0 is a vacuum. Atmospheric pressure at sea level is about 14.7 psi and this is added to any pressure reading made in air at sea level. The mixture calculations by the researchers to be accurate were based on psia.
psig	Pounds per square inch gauge, indicating that the pressure is relative to atmospheric pressure which is about 14.7 psi. Psig = 0 is no pressure above atmospheric pressure. The digital pressure gauges from Ashcroft all read in psig.
SCC	Stress Corrosion Cracking
SOP	Standard Operating Procedure
UCCLS	University of California Center for Laboratory Safety
UH	University of Hawaii at Manoa

Appendix B: Terminology

Explosion Proof

A topic that confuses many is “explosion proof”. Explosion proof is used as a rating for equipment that must be capable of containing any explosion originating from within. It also means that any type of spark generated inside the equipment is prevented from igniting gases, vapors, dust or fibers in the device’s surrounding environment.

The National Electric Code (NEC), NFPA 70 classifies hazardous conditions into 3 types: Class I - Gas and Vapor, Class II - Dust, and Class III - Fibers and Flyings.

A Class I hazard is created by the presence of flammable gases or vapors in the air, such as natural gas or gasoline vapor. When these materials are found in the atmosphere, a potential for explosion exists, which could be ignited if an electrical or other source of ignition is present. A Class II hazard is the presence of combustible dust and Class III is an area where there are easily-ignitable fibers or flyings present.

The classes are further divided into two kinds of hazardous conditions: Division 1 - Normal, and Division 2 - Abnormal. Normal means that a flammable mixture routinely exists such as a paint booth where flammable solvent vapors are constantly emitted. Abnormal conditions are when the flammable vapors are confined in a sealed system. It is present in air only due to the rupture of the system. Additional definitions for both can be found in the NEC.

Based on the the types of flammable materials, Class I is further divided into Groups A, B, C and D. Class II consists of Groups E, F, and G.

These are summarized in the following table from *U.S. Department of Labor OSHA Office of Training and Education May 1996*⁸³

⁸³ Note that other countries may have differing classifications such as the Canadian Electric Code (CEC) or the International Electrotechnical Commission (IEC)

Summary of Class I, II, III Hazardous Locations			
CLASSES	GROUPS	DIVISIONS	
		1	2
I Gases, vapors, and liquids (Art. 501)	A: Acetylene B: Hydrogen, etc. C: Ether, etc. D: Hydrocarbons, fuels, solvents, etc.	Normally explosive and hazardous	Not normally present in an explosive concentration (but may accidentally exist)
II Dusts (Art. 502)	E: Metal dusts (conductive, * and explosive) F: Carbon dusts (some are conductive, * and all are explosive) G: Flour, starch, grain, combustible plastic or chemical dust (explosive)	Ignitable quantities of dust normally are or may be in suspension, or conductive dust may be present	Dust not normally suspended in an ignitable concentration (but may accidentally exist). Dust layers are present.
III Fibers and flyings (Art. 503)	Textiles, wood-working, etc. (easily ignitable, but not likely to be explosive)	Handled or used in manufacturing	Stored or handled in storage (exclusive of manufacturing)

For example, acetylene has the lowest autoignition temperature (AIT) of all the gases, i.e., 302°C. Therefore, it is in Group A while hydrogen's AIT is much higher, i.e., 500°C, and is classified as a Group

B hazard. This means that acetylene has a higher hazard rating than hydrogen. Devices that come into contact with these gases must have a temperature below their AIT to prevent ignition.

This consideration pertains to the procedure in the POST 30 laboratory where the hydrogen/oxygen mixture of the open system bioreactor was vented into the laboratory fume hood. Could the flammable gases be exposed to any surfaces that exceeded the AIT of H₂? Can an incandescent light bulb get hot enough to ignite the H₂?

In a tragic fatal accident over 20 years ago, the owner of an acetylene supply company in New Jersey lowered a drop light (incandescent bulb) into an open acetylene receiver, it did not ignite the acetylene/air mixture. It ignited when he accidentally broke the bulb exposing the glowing tungsten filament.⁸⁴

The Fire Codes list specific design and installation requirements based on the hazard classification.

The POST 30 closed system bioreactor is classified as a Division 2 hazard since it is a sealed system. Where it becomes Division 1 is the venting of the reactors into the hood or the opening of the incubators.

An example of a dust explosion occurred a few years ago when a maintenance worker used a vacuum cleaner to clean an exhaust duct coated with partially oxidized silicon hydride particles. These are electrically non-conductive and a significant electrostatic charge developed within the vacuum cleaner which suddenly discharged igniting the dust cloud. If this system was to be classified it would be a Class II Division 2 hazard.

A problem in research laboratories is when to apply explosion proof requirements. Typically single cylinders of flammable gases in use are exempted. Examples of exempted use include a welding cart containing a cylinder of acetylene and oxygen or a Flame Ionization instrument with a hydrogen cylinder attached.

Intrinsic Safety

Devices are rated as intrinsically safe if explosive gases, vapors, dust or fibers from the surrounding environment cannot penetrate the device, which could potentially serve as a source of ignition.

Intrinsically safe devices have been tested at a 3rd party laboratory and proven to be safe for use in even the highest electrical classification of Class 1, Group A, Division 1 hazard category; therefore, they can be used for all hazardous environments requiring explosion proof conditions. In the US intrinsically safe testing and certification can be done by Factory Mutual (FM) or Underwriters Laboratories (UL).

Both are almost identical in their specifications which are listed as follows with UL⁸⁵ listed first and FM⁸⁶ in brackets.

For the purposes of this standard, normal atmospheric conditions are considered to be:

⁸⁴ NJ Star Ledger, March 27, 1996, pg 51

⁸⁵ UL-913 - Standard for intrinsically safe Apparatus and Associated Apparatus for Use in Class I, II, III, Division 1, Hazardous (Classified) Locations; http://ulstandards.ul.com/standard/?id=913_7, accessed 6/1/2016.

⁸⁶ FM-3610 - Approval Standard for intrinsically safe Apparatus and Associated Apparatus for Use in Class I, II, III, Division 1, Hazardous (Classified) Locations; http://www.npstc.org/documents/FM_IS_Standard_3610.pdf, accessed 6/1/2016

- a) An ambient temperature of 40°C (FM lists -25°C to 40°C)
- b) An oxygen concentration not greater than 21 percent by volume
- c) A pressure of one atmosphere (FM lists 0.8 to 1.1 atm)

When the Honolulu Fire Department HazMat unit made entry on the evening of the incident, they were aware that one hazard was a potential leak of hydrogen. All electrical devices they used in the “hot zone” such as walkie talkies and flammability gas detection meters had to be intrinsically safe.

Rotameters

The most common and most inexpensive gas flow metering and/or indicating device is a rotameter. This is described by Omega Inc. as:⁸⁷

Rotameter operation is based on the variable area principle: fluid flow raises a float in a tapered tube, increasing the area for passage of the fluid. The greater the flow, the higher the float is raised. The height of the float is directly proportional to the flow rate. With liquids, the float is raised by a combination of the buoyancy of the liquid and the velocity head of the fluid. With gases, buoyancy is negligible, and the float responds to the velocity head alone. The float moves up or down in the tube in proportion to the fluid flowrate and the annular area between the float and the tube wall. The float reaches a stable position in the tube when the upward force exerted by the flowing fluid equals the downward gravitational force exerted by the weight of the float. A change in flowrate upsets this balance of forces. The float then moves up or down, changing the annular area until it again reaches a position where the forces are in equilibrium. To satisfy the force equation, the rotameter float assumes a distinct position for every constant flow rate. However, it is important to note that because the float position is gravity dependent, rotameters must be vertically oriented and mounted.



⁸⁷ <http://www.omega.com/prodinfo/rotameters.html>

Rotameters typically come in 65 or 150 mm length tubes as shown in the figures above. For overpressure protection some manufacturers such as Dwyer or Matheson Trigas offer a safety blowout back panel should the glass tube shatter from overpressure. This will protect the user from glass fragments since it will be discharged from the back of the rotameter. Some users are not aware of this safety feature and defeat it by mounting the rotameter onto a rigid panel, blocking the back blow-out panel preventing it from relieving properly.

Appendix C: Marking and Labeling of Cylinders and Gas Piping

A major challenge for most laboratories is the labeling of cylinders and piping systems. In many cases a simple color code or a chemical symbol is used. While this is fine for the routine users in the laboratory it can be confusing to anyone new or a visitor. Even worse is when an incident occurs and quick assessments must be made in order to mitigate any hazard by an emergency response team that is not familiar with the system.

Fire Code and Industry standards require labeling of hazardous gas piping

NFPA 55 Compressed Gases and Cryogenic Fluids Code, 2016 edition⁸⁸

7.1.7 Labeling Requirements.

7.1.7.1 Containers. Individual compressed gas cylinders, containers, and tanks shall be marked or labeled in accordance with DOT requirements or those of the applicable regulatory agency.

7.1.7.2 Label Maintenance. The labels applied by the gas manufacturer to identify the liquefied or non-liquefied compressed gas cylinder contents shall not be altered or removed by the user.

7.1.7.3 Stationary Compressed Gas Cylinders, Containers, and Tanks.

7.1.7.3.1 Stationary compressed gas cylinders, containers, and tanks shall be marked in accordance with NFPA 704.

7.1.7.3.2 Markings shall be visible from any direction of approach.

7.1.7.4 Piping

7.1.7.4 Piping Systems.

7.1.7.4.1 Except as provided in 7.1.7.4.2, piping systems shall be marked in accordance with ASME A13.1, Scheme for the Identification of Piping Systems, or other applicable approved standards as follows:

- (1) Marking shall include the name of the gas and a direction-of-flow arrow.*
- (2) Piping that is used to convey more than one gas at various times shall be marked to provide clear identification and warning of the hazard.*
- (3) Markings for piping systems shall be provided at the following locations:*
 - (a) At each critical process control valve*
 - (b) At wall, floor, or ceiling penetrations*
 - (c) At each change of direction*
 - (d) At a minimum of every 20 ft (6.1 m) or fraction thereof throughout the piping run*

OSHA also requires labeling of containers with chemical and physical hazards⁸⁹. This was done with the Hazardous Materials Identification System (HMIS). GHS now incorporates pictograms and standard warning phrases.

⁸⁸ <http://www.nfpa.org/codes-and-standards/all-codes-and-standards/list-of-codes-and-standards?mode=code&code=55>, accessed 6/1/2016.

⁸⁹ <https://www.osha.gov/Publications/OSHA3636.pdf>, accessed 6/1/2016.

Appendix D: Compressed Gas Safety Standards and Regulations

A variety of industry association standards, government regulations and fire codes regulate the storage and use of compressed gases and cryogenic liquids. The codes and standards regulating compressed gas handling, storage and use are contained in:

- Federal OSHA Regulations
- Compressed Gas Association Standards
 - The primary compressed gas safety standard is the Compressed Gas Association (CGA) Pamphlet P-1 Safe Handling of Compressed Gas in Cylinders which is referenced by OSHA and the Fire Codes.
- International Fire Code (IFC)
- National Fire Protection Association (NFPA)

Federal OSHA Regulations⁹⁰:

1910.101(a)

Inspection of compressed gas cylinders." Each employer shall determine that compressed gas cylinders under his control are in a safe condition to the extent that this can be determined by visual inspection. Visual and other inspections shall be conducted as prescribed in the Hazardous Materials Regulations of the Department of Transportation (49 CFR parts 171-179 and 14 CFR part 103). Where those regulations are not applicable, visual and other inspections shall be conducted in accordance with Compressed Gas Association Pamphlets C-6-1968 and C-8-1962, which is incorporated by reference as specified in Sec. 1910.6.

1910.101(b)

Compressed gases." The in-plant handling, storage, and utilization of all compressed gases in cylinders, portable tanks, rail tank cars, or motor vehicle cargo tanks shall be in accordance with Compressed Gas Association Pamphlet P-1-1965, which is incorporated by reference as specified in Sec. 1910.6.

Key violations of the OSHA regulations for compressed gas cylinders are reported to be:

1. Unsecured cylinders. (CGA P-1:5.7.4)
2. Cylinders stored without cylinder caps. (CGA P-1: 5.4)(IFC Chapter 30, 3003.6.1)
3. Cylinders stored with hardware attached.
4. Cylinder valve left open when gas is not in use. (CGA P-1:5.8.1)
5. Non-compatible gases stored together. (CGA P-1:3.3.3)
6. Fire extinguishers not available when using flammable gas. (CGA P-1:6.2.3)
7. Safety shower, eyewash not available when using corrosive gas. (CGA P-1:6.5.1)
8. Gas mask, breathing apparatus not available when using toxic gas. (CGA P-1:3.6.1)
9. Empty and full cylinders stored together. (CGA P-1:3.3.4)
10. Failure to use basic personal protection.

⁹⁰ https://www.osha.gov/pls/oshaweb/owadisp.show_document?p_table=STANDARDS&p_id=9747

International Fire Code

The Fire Codes throughout most of the US (49 states) are based on the International Fire Code (IFC). This is a model code that is developed and maintained by the International Code Council. It is adopted as a regulation by state agencies or local jurisdictions. The code is updated every three years. Most jurisdictions lag behind by a few years in adopting the most recent edition. It is not known what Fire Code or edition has been adopted by the Honolulu Fire Department

Cylinders handled outside of research laboratories, i.e., in other use or storage areas will fall under the jurisdiction of the International Fire Code Standards 2015 and NFPA where it is referenced.

2015 Edition of International Fire Code Chapter 53 - Compressed Gases lists the general requirements for all compressed gases while the material specific chapters are

- Chapter 54 - Corrosive Materials
- Chapter 55 – Cryogenic Fluids
- Chapter 58 – Flammable Gases and Flammable Cryogenic Fluids
- Chapter 60 – Toxic and Highly Toxic Materials
- Chapter 63 – Oxidizers, Oxidizing Gases and Oxidizing Cryogenic Fluids
- Chapter 64 – Pyrophoric Materials
- Additional requirements will be found in Chapter 50 Hazardous Materials.

National Fire Protection Association (NFPA)

State and local jurisdictions also recognize some of the standards by the National Fire Protection Association (NFPA). In some cases these are referenced by IFC. These are generally more comprehensive since the committees are comprised of regulators, manufacturers, users and industry associations. The most applicable for compressed gases are:

1. NFPA 55 Compressed Gases and Cryogenic Fluid Code, 2016 edition (Material Specific)
2. NFPA 45 Standard on Fire Protection for Laboratories Using Chemicals, 2015 edition (Use specific)

Recognizing the unique requirements of research laboratories a standalone standard NFPA 45 “Standard on Fire Protection for Laboratories Using Chemicals”. While NFPA 45 is not referenced by the IFC it does contain specific requirements that should be adopted as best practice for University Laboratories.

Key definitions are in Chapter 4 Classifications which classifies the Laboratories based on hazards

4.1 General.

4.1.1 This chapter shall classify laboratory units based on the amount of flammable and combustible liquids in use within the unit.

4.1.2 This chapter also shall define the existence of an explosion hazard in a laboratory unit or in a laboratory work area.

4.2 Laboratory Unit Fire Hazard Classification.

4.2.1* Classifications.

4.2.1.1 Laboratory units shall be classified as Class A (high fire hazard), Class B (moderate fire hazard), Class C (low fire hazard), or Class D (minimal fire hazard), according to the

quantities of flammable and combustible liquids specified in Table 9.1.1(a) and Table 9.1.1(b).

4.2.2 Additional Requirements for Educational and Instructional Laboratory Units.

4.2.2.1 Instructional laboratory units shall be classified as Class C or Class D laboratory units.

4.2.2.2 Educational laboratory units shall be classified as Class D or shall be limited to 50 percent of the flammable and combustible liquids quantity for Class C laboratory units presented in Table 9.1.1(a) and Table 9.1.1(b).

Chapter 10 is fairly liberal in the number and types of compressed gases allowed in the laboratory for use without the safety controls required by the Fire code for other users. A researcher can have multiple incompatible small cylinders within the same laboratory fume hood in use without the need to isolate them in separate ventilated cabinets.

While this is normally not the practice by many Laboratories, cylinders that are not in use must be stored outside of the laboratory in areas regulated under other NFPA or IFC Compressed Gas standards.

Other NFPA 45 requirements to consider for inclusion into the University Best Practices for cylinders in Chapter 10 include:

- 10.4.1 has special ventilation requirements for gas cylinders
- 10.1.6 defines cylinders in use
- 10.1.6.8 defines the limit for gases in Educational Laboratories
- Fire retardant clothing when handling pyrophoric materials (6.6)
- Cylinders shall only be handled by trained personnel (10.1.1) Annex E & F

Additional sections to be considered are:

- Chapter 11 Laboratory Operations and Apparatus has requirements for distillation systems, gas mixing, and pyrophoric handling
- Chapter 12 Educational and Instructional Laboratory Operations, due to the many incidents that have occurred, this is the most restrictive of all the Laboratory classifications.
- Chapter 13 Hazard Identification

Of interest is the Laboratories handling section in Annex C Information on Explosion Hazards and Protection

C.1 Scope. This annex is intended to provide laboratory management with information to assist in understanding the potential consequences of an explosion in a laboratory and the need for adequately designed protection. It is not intended to be a design manual.

This section contains an excellent summary of items to consider as well as guidelines for protection. This should be reviewed by all universities handling flammable gases or liquids in large quantities.

Appendix E: Compressed Gas Safety Guidelines

Compressed Gases

Besides their respective chemical and physical hazards, many of the compressed gases comprise a pressure hazard. The more common gases such as nitrogen, hydrogen or helium are filled in high pressure cylinders to pressures exceeding 2,000 psig. In some specialty applications such hydrogen fueling systems the pressures can exceed 10,000 psig. Systems that handle these gases must be designed to handle any foreseeable pressure due to temperature or mechanical failure. For most applications a pressure regulator is used to reduce the pressures to a safer level. Pressure relief devices are also required to protect the systems from overpressure.

Cylinder valve outlet connections are selected based on the gas characteristics. A variety of valve outlet connections are used to prevent incompatible gases from being connected together. Hydrogen for example has a CGA 350 connection which is a nipple seal with a nut that is a left handed thread. Oxygen is a CGA 540 which is also a nipple seal but the same size nut is a right handed thread. The universal rule worldwide is to have a notch on the nut to indicate that it is left handed. A CGA 350 connection is shown in the following figure.

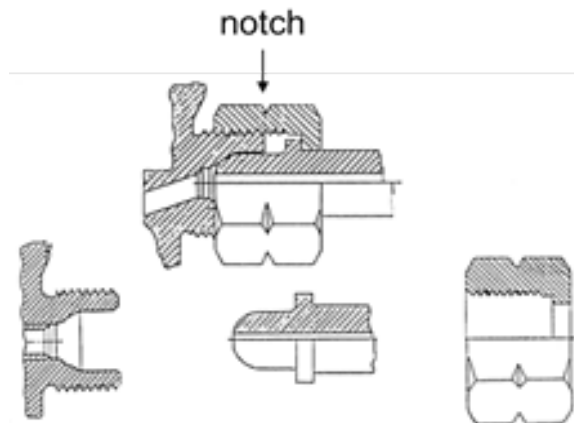

Schematic of CGA 350 connection for hydrogen gas.

Selection of outlets is based on CGA Standard V-1 Compressed Gas Cylinder Valve Outlet and Inlet Connections. Regulators should be ordered with the appropriate CGA connection attached. Adapters shall never be used to adapt to a regulator used for another gas.

Pure oxygen gas presents a serious combustion hazard, so oxygen regulators in particular must be clean and free of all contaminants. Since oils and grease become highly combustible in the presence of oxygen, never use oil, grease, or any other petroleum-based or flammable substance on or around oxygen equipment. Further, DO NOT change regulators from one gas service to another by changing the CGA connections. Changing a different gas regulator into an oxygen regulator can result in fire or explosion due to contaminants in the regulator.

Users should be aware of some basic safety rules for the following compressed gases groupings: Note that these are not comprehensive guidelines, the user should consult the supplier technical data sheets or Safety Data Sheets.

1. **Extremely flammable gases:** Hydrogen and Acetylene are extremely flammable because of their low ignition energies, wide flammable ranges and high reaction speeds. They are also lighter than air and have unique chemical properties. Therefore, there are special safety considerations:
 - Proper grounding and bonding of the system is required.
 - Intrinsically safe electrical devices are required.
 - Equipment components that are in contact with hydrogen should be inspected regularly since hydrogen embrittlement can occur with low alloy steels at operating pressures approaching their tensile strength.
 - Non metal tubing is unsafe because hydrogen will permeate to the exterior surface. Increasing temperatures increase the rate.
 - High pressure releases of hydrogen almost always ignite.
 - Hydrogen burns without a visible flame.

2. **Oxygen:** High pressure oxygen is extremely reactive. Even low pressure oxygen can be extremely reactive as shown by the Apollo 1 fire in 1967 which killed the 3 astronauts. After that incident, NASA conducted numerous studies on oxygen safety.

Equipment for use with oxygen must be properly designed and maintained:

- Systems must be oxygen cleaned using the methods described in CGA Pamphlet G-4.1(see below)
- Valves must be opened slowly to avoid adiabatic compression heat.
- Systems must be made with compatible materials. Aluminum or carbon steel will react at very low pressures.
- Flammable tubing such as polyethylene (PE) are not safe to use. They can readily ignite and burn with high energy output. With few exceptions, materials become more flammable in oxygen as pressures increase. This includes metals, plastics, elastomers, lubricants, and contaminants. In fact, nearly all polymer materials are flammable in 100 percent oxygen at atmospheric pressure. Guidance is found in: Rosales, K. R., Shoffstall M. S., Stoltzfus J. M. "Guide for Oxygen Compatibility Assessments on Oxygen Components and Systems" NASA/TM-2007-213740, March 2007
- Systems must be marked and dedicated for oxygen service:
 - Oxygen fires have been caused as a result of surface contaminants in the system interior such as machine oil or metal particle impact. Metals such as aluminum or titanium should not be used in high pressure oxygen service. Aluminum can ignite at pressures as low as 25 psig (Alloy 6061) while 304 stainless steel does not ignite until 725 psig. I.
 - Accidents have occurred when users needing an oxygen regulator replaced the CGA connection from a regulator used in another service with a CGA 540 connection and attached it to the oxygen cylinder. When the cylinder valve was opened, the adiabatic compression heat reached the autoignition temperature of the contaminant in pure oxygen.



Regulator used for another gas service was adapted for oxygen use and exploded when the cylinder valve was opened.

- Air Products Safetygram 1 Oxygen states: “Systems used in oxygen service must meet stringent cleaning requirements to eliminate any incompatible contaminants.”
- CGA Pamphlet G-4.1, “Cleaning Equipment for Oxygen Service,” describes cleaning methods for equipment used in oxygen service.
- CGA Pamphlet O2-DIR, “Directory of Cleaning Agents for Oxygen Service,” provides comparative information on cleaning agents used to clean oxygen equipment

These incompatible contaminants—many of which are very difficult to detect—can be the initial fuel for a promoted ignition event. (Luxfer Cylinders Inc.)

- Machining oils (including residual oil film)
- Hydrocarbon-based grease and lubricants (including compressor oil)
- Some soaps, detergents, solvents and cleaning solutions, especially those that contain organic compounds
- Skin lotions and emollients and cosmetics
- Sun-tanning oils and lotions
- Human skin oil and bodily fluids
- Insects and insect body parts
- Paint, wax, and marking crayons
- Carbon dust from filtration systems
- Metal fines, filings, scale and burrs
- Chrome chips (usually from valves and other chrome-plated parts)
- Rust particles and dust
- Metallic oxides in general
- Airborne soot and dust
- Pipe thread sealants
- Residue from soapy water and leak-detection fluids used to check for leaks
- Lint from cloths used in cleaning

- Any other material containing organic compounds and hydrocarbons

Once these are cleaned from the system, it must be protected to prevent recontamination when the system is not being used.

NASA recommends a formal oxygen compatibility assessment process that may be used as either design guide or as an approval process for components and systems. The required oxygen compatibility assessment procedure is:

- Determine the worst-case operating conditions
- Assess the flammability of system materials
- Evaluate the presence and probability of ignition mechanisms
- Determine the kindling chain, which is the potential for a fire to breach the system
- Analyze the reaction effect, which is the potential loss of life, mission, and system functionality as the result of a fire
- Identify the history of use
- Report the results of the analysis

3. **Highly toxic gases:** DOT as well as the Fire Codes require additional safeguards for highly toxic gases such as arsine, phosphine or diborane

- 49 CFR 173.40: Performance tested cylinder valve protection caps. These are marked and should not be exchanged with other cylinder caps.
- 49 CFR 173.40: Cylinder valve outlets must have a gas tight outlet seal. When loosening this, proper PPE and safety procedures must be followed.
- 49 CFR 173.40: Requires a metal diaphragm valve, the only exception is the use of a packed valve with a gas tight stem cap (phosgene, cyanogen chloride, fluorine).
- Most of the highly toxic gases have an olfactory threshold well above the danger levels. Electronic leak detection must be used to test for leaks.
- Arsine in any quantity requires a CFATS level 1 security plan.

General Guidelines for Compressed Gas Safety

OVERALL GUIDELINES

1. Cylinders shall not be stored or used if the contents are not properly identified. Never use color as the identifier.
2. Labels and markings on the cylinder shall not be covered, defaced or removed.
3. All compressed gases shall be in approved cylinders made to recognized government (Department of Transportation, United Nations, Korea Specialty Gas Corporation, etc) specifications.
4. Compressed gas cylinders shall be used and stored only in designated locations in the facility.
5. Proper PPE shall be worn at all times.
6. Compressed gases shall be used only by trained and qualified personnel.
7. Compressed gas cylinders shall be transported only by trained and qualified personnel.

8. Valve outlet connections used for compressed gas cylinders shall conform to nationally or regionally recognized standards in the US the Compressed Gas Association (CGA), Japan the Japanese Industrial Standard (JIS), Germany the Deutsches Institut für Normung e.V (DIN)
9. Liquefied gas cylinders shall be used, transported and stored with the vapor space in communication with the pressure relief device. (Exceptions include forklift propane cylinders that are designed to be horizontal.)
10. Gas cylinders should have a status tag to indicate status.

HANDLING AND TRANSPORTATION WITHIN THE FACILITY

1. Cylinders are to be moved using approved cylinder handcarts. Approved handcarts are designed for transporting cylinders, for physical stability they have outrigger wheels. Dragging, rolling or lifting by the cylinder cap is not approved. They shall not be dropped or struck against each other or other surfaces.
2. Cylinder rolling is authorized only for short distances between the cylinder cart and the final use or storage point (less than 5 feet).
3. Properly designed cylinder carts shall only be used for a maximum of 2 cylinders.
4. All approved cylinder carts shall have a restraining device such as a chain to prevent a cylinder from falling out.
5. All cylinders shall be transported with the cylinder valve protection cap on.
6. All cylinders shall be leak tested prior to removal from storage or use area.
7. Cylinders are not to be left unattended during transportation.
8. Transport only at approved times in the facility.
9. Transport only through approved routes.
10. Large cylinders can be a significant physical hazard when handling. If one should tip, do not try to catch it! Let it fall.
11. Lifting magnets, cylinder caps or slings shall not be used to move cylinders using a crane or hoist. Cylinders shall only be lifted using specially designed cages or cradles.
12. Forklift movement shall only be in skids/cradles designed for cylinders.
13. With the exception of lecture bottles, cylinders shall be moved standing upright.

STORAGE

1. Cylinders shall be stored in dedicated areas conforming to local/national regulations.
2. Storage areas shall have adequate natural or mechanical ventilation.
3. The area shall be protected from the weather.
4. The area shall be free of standing water.
5. Cylinders shall be secured using straps or chains at the midsection of the cylinder. In earthquake areas they shall be secured at 2 points.
6. Cylinders shall be grouped into compatible groups based on their primary hazard class.
7. Incompatible groups shall be separated by a fire partition a minimum of ½ hr fire rating or a distance of 20 feet.
8. Segregate full and “empty” cylinders.
9. Storage areas shall be adequately marked.
10. Storage areas shall be secured from unauthorized entry.
11. Storage areas shall have adequate lighting.

12. Cylinders should not be stored for extended periods of time. In general 3 years is the maximum.
13. Cylinders of hydrogen fluoride and hydrogen bromide should be returned to the supplier within 2 years.

USE SAFETY

1. All cylinders are to be placed into the final use area/cabinet and immediately restrained using cylinder straps or chains, prior to removal of the cylinder cap.
2. Cylinders are not be subjected to temperatures outside of the following range: -20 °F (-29 °C) to 125 °F (52 °C).
3. Only properly designed heating systems are to be used. For safety a second independent temperature controller shall be used to alarm and shut off the heating system.
4. Valve outlet adapters to change the valve outlet connection to match the gas cabinet pigtail are prohibited.
5. Teflon tape or pipe thread sealant shall not be used on any cylinder CGA outlet connection threads.
6. Connection to the valve outlet shall be smooth and not forced.
7. Tools such as wrenches shall not be used to open or close valves unless they are designed for wrench operation, in this case a short wrench 6" (15 cm) shall be used.
8. Tools or other objects shall not be inserted into the cylinder cap vent hole help remove it.
9. Gas systems set up for one gas service shall not be used for other services unless formally reviewed and approved.
10. All compressed gas cylinders in use, except low vapor pressure gases such as boron trichloride, shall have a pressure regulator to lower the pressure.
11. "Buddy System" when changing highly toxic or pyrophoric gas cylinders.
12. Highly toxic or high-pressure pyrophoric cylinder valves shall have a RFO (Restrictive Flow Orifice) installed sized for the size of the abatement system.
13. Only systems designed and cleaned for oxygen service shall be used for oxygen and other oxidizer gases.
14. Strong fluorine gases (ClF₃, F₂, NF₃, etc) shall only be used in systems that have been oxygen cleaned and fluorine passivated.
15. Fluoride gases that hydrolyze in air (ClF₃, F₂, SiF₄, BF₃, AsF₅) create a HF exposure hazard when released.

SYSTEM DESIGN RULES

1. Whenever a cryogenic liquid or a liquefied gas can be trapped between two valves install a pressure relief valve to relieve the liquid expansion.
2. Dedicated high pressure purge gas cylinders shall be used for compatible groupings of highly toxic or pyrophoric gases.
3. Purge gas cylinders shall only be shared between compatible gases.
4. Piping/tubing through a wall shall be sleeved to physically protect them.
5. Piping/tubing hidden behind walls, ceiling or floor shall be welded, there should be no hidden mechanical connections.

Guidelines for Cylinder/Pressure Vessel Filling Safety

Under the ASME regulations any container larger than 1 gallon (3.8 liter), with a diameter larger than 6" and a pressure higher than 15 psig must be designed as a pressure vessel under ASME (American Society of Mechanical Engineers) regulations or as a cylinder under the DOT (Department of Transportation) Regulations⁹¹.

General

1. Prior to executing any new procedure to fill cylinders in the laboratory, there must be a detailed hazard review done and documented by people and companies familiar with the materials and hazards.
2. Cylinder must be an approved ASME or DOT Pressure Vessel with a design pressure equal to or less than the intended operating pressure. MAWP must never be exceeded.
3. Cylinder owned by others may not be filled without their consent.
4. Cylinder must be labeled with contents as per GHS.
5. Cylinder must be marked with the maximum allowable fill pressure/amount.
6. Cylinders for filling of liquefied gases must have the tare weight based on the as used condition, e.g cylinder cap off.
7. Cylinder must have pressure relief device as defined by CGA S1.1 "Cylinder Pressure Relief Devices" or ASME Unfired Pressure Vessel Requirements typically MAWP or less.
8. Cylinder can only be filled by someone trained on the procedure.

Fill Amount

To insure that dangerous amounts of gas are not put into a cylinder, care must be taken to calculate the allowable amount:

1. Scales used to weigh cylinders must be routinely calibrated. Check weights are used to test the scale prior to use.
1. Pressure in the cylinder may not exceed the design pressure under any temperature that the cylinder will be exposed.
2. Only cylinders constructed of aluminum or stainless steel may be exposed to temperatures less than -30°F (-34.4°C).
3. In the US cylinder fill densities have been determined based on a maximum temperature of 130°F (54.4°C) as defined in the transportation regulations.
4. They must be immediately reweighed after filling and the cylinder has been disconnected to verify content.
5. Some gases such as BF₃ or SiH₄ have high thermal expansion ratios that must be taken into account.

Visual Inspection Before Fill

A prefill inspection must be done prior to each fill. This must be recorded

⁹¹ Title 49 Federal Code of Regulations

1. Prior to filling, cylinders must be visually inspected for physical damage, gouges, cuts, dents, pits, corrosion as per CGA C-6.
2. Cylinders showing any evidence of exposure to fire or welding cannot be refilled until requalified.
3. Cylinders that have been modified by drilling or welding additional piping cannot be refilled until requalified.
4. Cylinders must be weighed to determine if they contain any residue.

Things that can compromise cylinders

1. Gases that can cause embrittlement of carbon steel cylinders include:
 - a. Ammonia
 - b. Carbon Monoxide
 - c. Carbon Dioxide
 - d. Hydrogen
 - e. Hydrogen Sulfide
 - f. Hydrogen Chloride

Review material of construction before proceeding

1. Oxygen systems must be properly designed and cleaned. These must be marked and dedicated for oxygen use. Aluminum systems cannot be used for oxygen. Aluminum cylinders are authorized.
2. Fluorine and other strong fluorine gas (ClF_3 , BrF_3) systems must be constructed of approved materials, oxygen cleaned and fluorine passivated
3. Aluminum cylinders cannot be used for the halogen acid gases (Cl_2 , HBr , HCl) unless they are gas mixtures at low ppm concentrations.

Mixing Gases

Incompatible gases in the same cylinder can be dangerous.

1. Gases that are reactive with each other shall not be mixed in cylinders
 - a. Flammable and Oxidizer gases
 - b. Acid and Alkaline gases
2. If a fuel and oxidizer gas are to be mixed together, the precautions in CGA P-58, "Safe Preparation of Compressed Oxidant-Fuel Gas Mixtures in Cylinders" must be followed.

Some gases are unstable and require stabilizers.

Some gases are unstable and can auto-decompose or polymerize in a self sustaining exothermic reaction. The byproducts and heat can violently rupture the cylinder.

1. Acetylene must never be filled to a pressure above 15 psig. Pressures higher than this must be in special cylinder filled with specially designed solid and solvent. Copper must never be used with acetylene.
2. Gases that require a stabilizer:

- a. Tetrafluoroethylene
 - b. Tetrafluorohydrazine
 - c. Cyanogen Chloride
3. Gases such as Diborane are limited in the maximum fill amount since the full decomposition can create 3 times the amount in H₂.
 4. Germane fill density assumes the instantaneous decomposition and heat.
 5. To minimize adiabatic compression heat from initiating a reaction, Nitric Oxide fill is limited to 500 psig and Nitrogen Trifluoride to 1450 psig.

Miscellaneous

1. Valve Outlet Connections shall follow CGA V-9.
2. Cylinders must be tested and inspected as required.
3. When a cylinder valve is opened and no gas comes out, the safety rule is to determine if the valve is plugged or inoperable by pressurizing the valve outlet to see if gas enters the cylinder.
4. A cylinder is never considered empty until it has been purged of its contents.

Appendix F: Forensic Testing Report

The WHA Forensic Testing Report can be accessed here:

http://cls.ucla.edu/images/document/WHA_Report.pdf

Appendix G: Biographies

Dr. Craig Merlic

Professor Merlic obtained his B.S. degree in chemistry from the University of California, Davis and his Ph.D. in organic chemistry from the University of Wisconsin, Madison. After a postdoctoral position at Princeton University he joined the faculty in the UCLA Department of Chemistry and Biochemistry in 1989. Professor Merlic's research focuses on applications of transition metal organometallic chemistry to organic synthesis and extends from catalysis to synthesis of new chemotherapeutic agents. He teaches courses on introductory organic chemistry, advanced organic synthesis, organometallic chemistry, scientific ethics, and safety in chemical and biochemical research. He has received awards for his teaching, educational projects, and scientific research. His research has been supported by the National Science Foundation, the National Institutes of Health, the Petroleum Research Fund and various corporate sponsors.

Professor Merlic has been active promoting chemical safety at UCLA and the University of California system. He serves as chair of the Department Safety Committee, the campus-wide Chemical and Physical Safety Committee, and the UCLA Safety Oversight Committee. At the University of California system-wide level, he is the Executive Director of the UC Center for Laboratory Safety (<http://cls.ucla.edu>) that has ongoing projects to improve laboratory safety policies, procedures, and training based on scientific studies. He works with an information technology group located at UC Davis creating safety software tools for use at all ten university campuses. He serves as a Board Member for University of California Risk & Safety Solutions.

Mr. Eugene Ngai

Eugene Ngai holds a Bachelor of Science in Chemical Engineering and a Master in Environmental Engineering. He has over 40 years of Specialty Gas experience in production, laboratory, R&D, engineering, safety and executive management positions. He retired from Air Products in 2009 and formed Chemically Speaking LLC a compressed gas safety and emergency response training and consulting corporation. Chemically Speaking LLC currently has numerous multi-year agreements to advise manufacturers, suppliers and users of specialty compressed gases, primarily in the semiconductor, LCD or photovoltaic industries.

He is active in a number of worldwide industry association working groups including CGA G-13 (Silane), NFPA 55 (Industrial and Medical Gases), NFPA 400 (Hazardous Materials), NFPA 318 (Semiconductor), SEMI EHS, SESH and UN TC58 SC2 WG7 (Gas Toxicity, Flammability, Oxidizer). He coordinated silane release testing in 2011 and 2012 to gather data for revision of the CGA G-13 standard on silane, a pyrophoric gas that has been involved in over 16 fatal accidents.

He has made over 200 presentations worldwide on Emergency Response, Product Safety, Gas Technology and Environment and has campaigned extensively on silane safety. He chaired twelve one day silane safety seminars, in Taiwan, Korea, Singapore, US and Europe starting in 2006. He conducts compressed gas safety and emergency response classes throughout the

world. He teaches courses on compressed gas safety and emergency response and has trained over 10,000 users from government agencies, universities, gas manufacturers and semiconductor fabrication facilities. He has also taught at Fire Academies worldwide, including New York, Honolulu, San Jose, Camden County and Singapore and as well as HazMat Conferences. Over 4,500 firefighters have been trained. In 1988 he designed the sold the 5501 and 5502 ERCV's which can be used to isolate high pressure leaking gas cylinders to safely transport them to a remediation site. These have become the industry standard, known as the Solkatronic. He has five patents on gas safety devices.

Dr. Imke Schroeder

Dr. Imke Schroeder is the Research project manager at the UC Center for Laboratory Safety (<http://cls.ucla.edu>). She is also an Adjunct Associate Professor in the Department of Microbiology, Immunology and Molecular Genetics (MIMG) at UCLA. Dr. Schroeder received her Ph.D. in Microbiology from the University of Marburg, Germany, and performed her postdoctoral training at UCLA. After a year as senior researcher at the Veterans Administration Medical Center in San Francisco, she joined the Department of MIMG in 2001, where she has worked on virulence determinants of the select agent *Burkholderia pseudomallei*. She has extensive experience in diverse areas of microbiology including research on extremophiles and select agents. She has technical expertise in various bacterial cell culture methods including anaerobic and microaerophilic technics, and bioreactor fermentation with H₂ and O₂. She has cultured the hyperthermophilic bacterium *Aquifex pyrophilus* with H₂ and O₂ at elevated temperatures on a 80 L scale for protein purification purposes. She has also performed mammalian cell cultures, protein purifications, various gene manipulations, RNA-sequencing and high throughput screening methods. She is an expert in the risk assessment associated with each agent and process.

Her current academic activities include research on laboratory safety, safety culture survey design and analysis, accident analysis, identification of leading factors for accidents and unsafe behaviors, and laboratory safety training. Furthermore, she manages subject matter experts for the Safety Training Consortium (<http://safety-consortium.org>) and co-organizes workshops on laboratory safety.

Mr. Kenneth Smith

Ken Smith is the Executive Director for Environmental Health and Safety for the University of California. In this position with the UC Office of the President, he provides systemwide direction, guidance and expertise on matters of Environmental Health and Safety to all ten UC campuses, five UC Health Medical Centers that encompass eleven hospitals, as well as Agricultural and Natural Resources and three UC managed National Laboratories.

Ken has served the UC system for 24 years in the areas of Radiation Safety and Research Safety. An alumnus of UC Santa Cruz, He received his degree in Biochemistry and Molecular Biology and holds board certifications in both Industrial Hygiene and Health Physics.

Ken is a nationally recognized expert in Health and Safety in complex research environments. He has been an invited speaker for organizations such as the American Chemical Society, American Industrial Hygiene Association, the California State University System, the California Industrial Hygiene Council, and the Campus Safety Environmental Health and Management Association. Ken also serves on the boards of the Laboratory Safety Institute and the UC Center for Laboratory Safety.

WHA International

WHA International, located in Las Cruces New Mexico, helps clients understand, evaluate, and mitigate hazards and fire risks associated with oxygen and other hazardous fluids and gases through engineering analysis, testing, training and forensic investigations. Its core business includes root-cause analysis of high pressure gas systems, fire hazards training, and oxygen compatibility testing of materials and components. WHA has been recognized since the early 1990s as a preeminent engineering firm with engineers and experts who have extensive experience across a wide range of scientific disciplines. Its engineers have formal training, including advanced degrees and licensures. WHA was founded by an engineering professor in 1987 and its focus has always been to provide just resolution of forensic engineering disputes, using the scientific method for testing and evaluation. The current leadership team is capitalizing on the industry niche services that have taken WHA from a local to an international company. WHA advances the technologies of oxygen safety, forensic engineering and fire sciences throughout the world. With the advantageous synergy that is created from WHA's industry experience, innovative drive and custom designed testing facilities, the WHA team is known worldwide for expertise in oxygen and fire-safety technologies, and aims to develop innovative solutions for clients' complex problems.